



1/3 SCALE MORANE SAULNIER AI

Code : SEA 358

ASSEMBLY MANUAL

“Graphics and specifications may change without notice”.



Specifications:

Wingspan----- 103 in (262 cm).

Wing area----- 1839.9 sq.ins (118.7sq.dm).

Weight----- 25.3-26.9 lbs (11.5-12.2 kg).

Length----- 66.7 in (169.3 cm).

Engine----- 50cc-62 cc

Radio----- 5 channels with 6 servos

Motor 360/ 3000watt/ ESC 160A-200A/ Lipo 12s;

Electric propeller 24x10 - 26x8

ITEM CODE : SEA 358



INTRODUCTION

Thank you for choosing the **1/3 Scale Morane Saulnier AI** ARTF by **SG MODELS**. The **1/3 Scale Morane Saulnier AI** was designed with the intermediate/advanced sport flyer in mind. It is a semi scale airplane which is easy to fly and quick to assemble. The airframe is conventionally built using balsa, plywood to make it stronger than the average ARTF, yet the design allows the aeroplane to be kept light. You will find that most of the work has been done for you already. The motor mount has been fitted and the hinges are pre-installed. Flying the **1/3 Scale Morane Saulnier AI** is simply a joy.

This instruction manual is designed to help you build a great flying aeroplane. Please read this manual throughly before starting assembly of your **1/3 Scale Morane Saulnier AI**. Use the parts listing below to indentify all parts.

WARNING

Please be aware that this aeroplane is not a toy and if assembled or used incorrectly it is capable of causing injury to people or property. WHEN YOU FLY THIS AEROPLANE YOU ASSUME ALL RISK & REponsibility.

If you are inexperienced with basic R/C flight we strongly recommend you contact your R/C supplier and join your local R/C model Flying Club. R/C Model Flying Clubs offer a variety of training procedures designed to help the new pilot on his way to successful R/C flight. They will also be able to advise on any insurance and safety regulations that may apply.

KIT CONTENTS

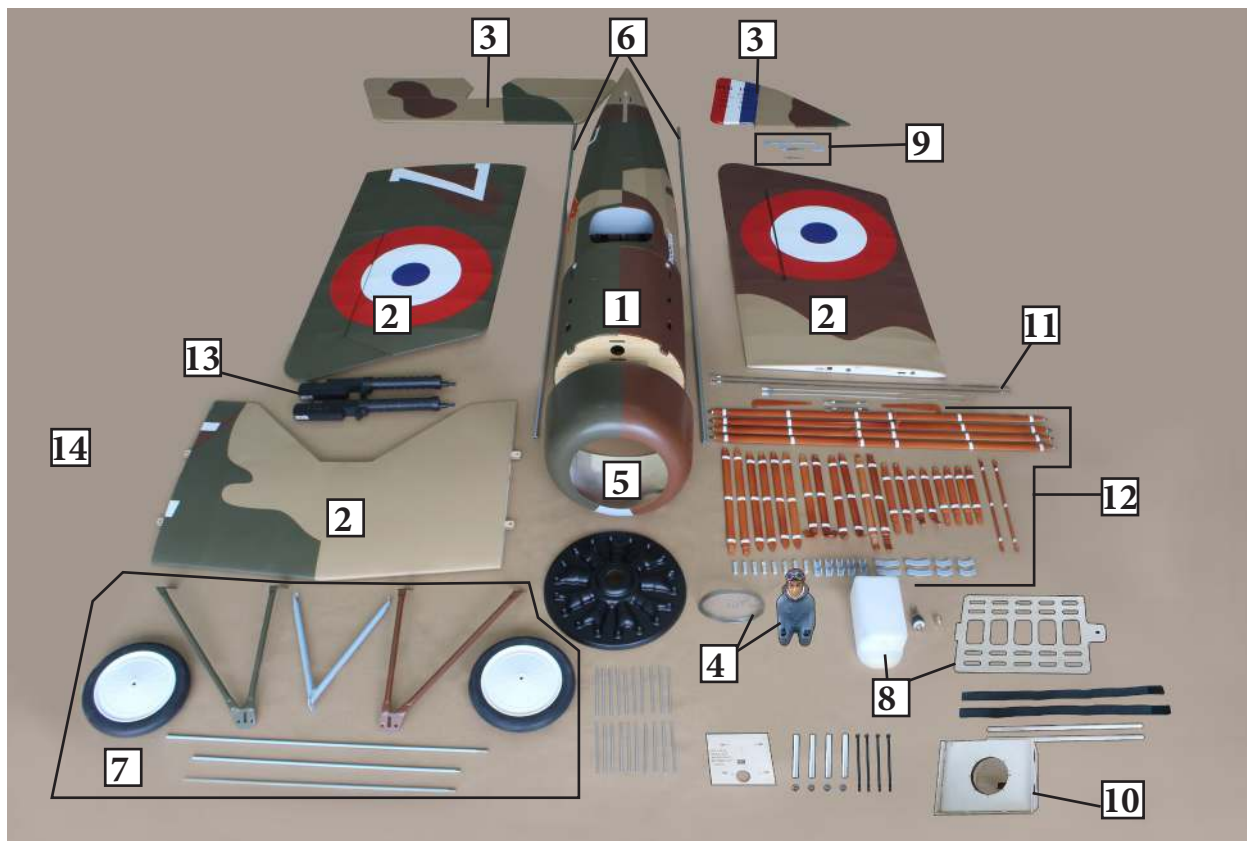

KIT CONTENTS

SEA 358 1/3 Scale Morane Saulnier AI

1. Fuselage
2. Wing set (3)
3. Tail set (2)
4. Canopy and Window
5. Cowling
6. Wing tube
7. landing gear
8. Fuel tank
9. Tail wheel
10. Ep Motor box
11. Pushrod set
12. Wing struts (2)
13. Gun

ADDITIONAL ITEMS REQUIRED

- 50-62cc gasoline engine.
- Computer radio 5 channel with 6 servos.
- Glow plug to suit engine.
- Propeller to suit engine.
- Protective foam rubber for radio system.

TOOLS & SUPPLIES NEEDED

- Thin cyanoacrylate glue.
- Medium cyanoacrylate glue.
- 30 minute epoxy.
- 5 minute epoxy.
- Hand or electric drill.
- Assorted drill bits.
- Modelling knife.
- Straight edge ruler.
- 2mm ball driver.
- Phillips head screwdriver.
- 220 grit sandpaper.
- 90° square or builder's triangle.
- Wire cutters.
- Masking tape & T-pins.
- Thread-lock.
- Paper towels.

HINGING THE AILERON

Note : *The control surfaces, including the ailerons, elevators, and rudder, are prehinged with hinges installed, but the hinges are not glued in place. It is imperative that you properly adhere the hinges in place per the steps that follow using a high-quality thin C/A glue.*

Carefully remove the aileron from one of the wing panels. Note the position of the hinges.

1.

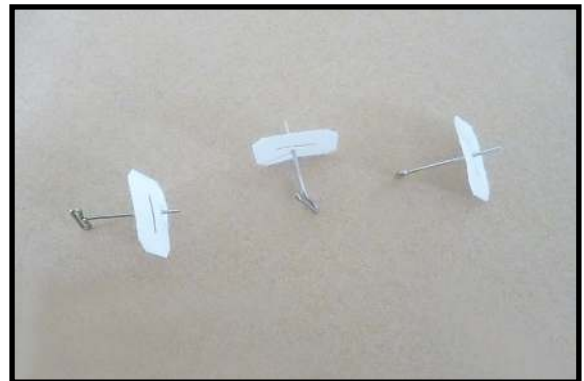

Remove each hinge from the wing panel and aileron and place a T-pin in the center of each hinge. Slide each hinge into the wing panel until the T-pin is snug against the wing panel. This will help ensure an equal amount of hinge is on either side of the hinge line when the aileron is mounted to the aileron.

2.

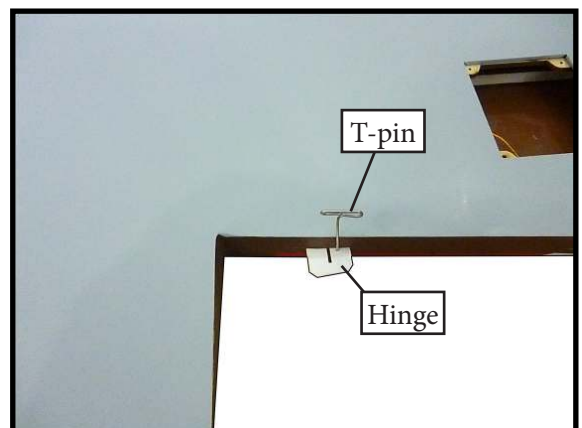

Slide the wing panel on the aileron until there is only a slight gap. The hinge is now centered on the wing panel and aileron. Remove the T-pins and snug the aileron against the wing panel. A gap of 1/64" or less should be maintained between the wing panel and aileron.

Deflect the aileron and completely saturate each hinge with thin C/A glue. The ailerons front surface should lightly contact the wing during this procedure. Ideally, when the hinges are glued in place, a 1/64" gap or less will be maintained throughout the length of the aileron to the wing panel hinge line.

NOTE : The hinge is constructed of a special material that allows the C/A to wick or penetrate and distribute throughout the hinge, securely bonding it to the wood structure of the wing panel and aileron.

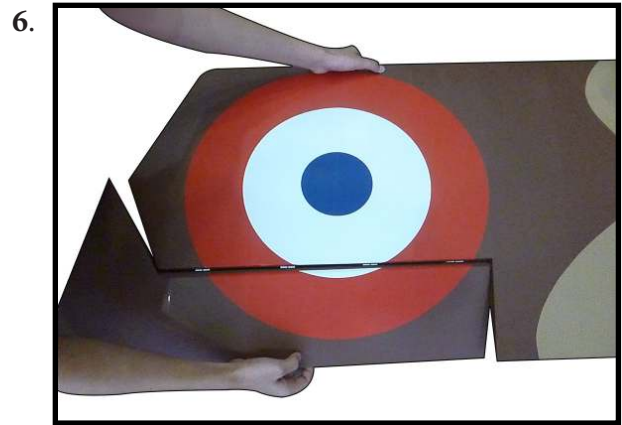
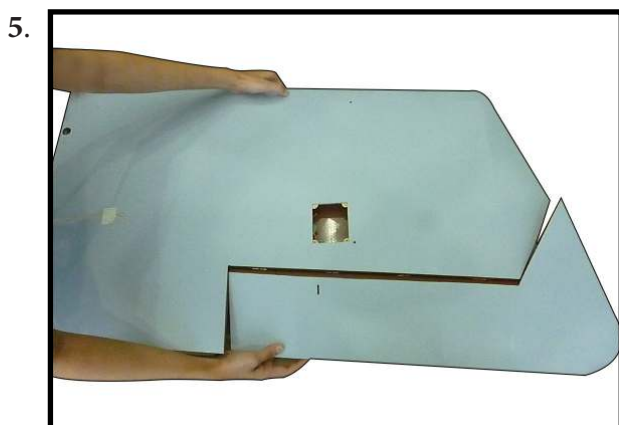
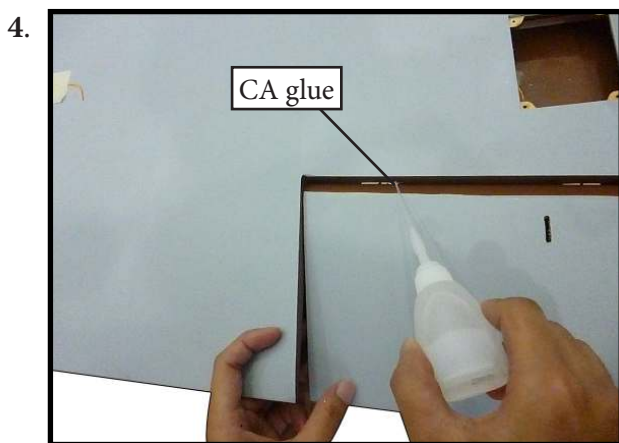
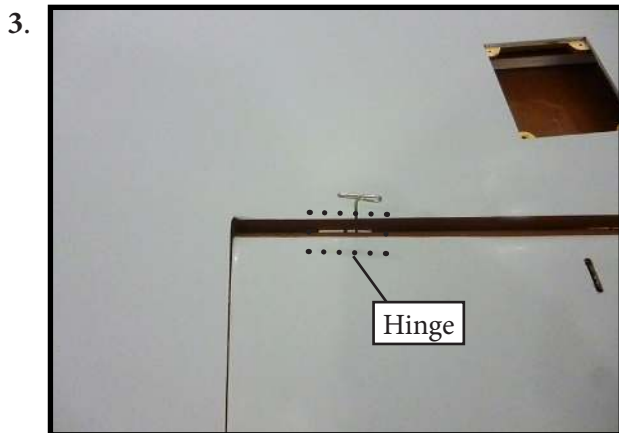

Turn the wing panel over and deflect the aileron in the opposite direction from the opposite side. Apply thin C/A glue to each hinge, making sure that the C/A penetrates into both the aileron and wing panel.

Using C/A remover/debonder and a paper towel, remove any excess C/A glue that may have accumulated on the wing or in the aileron hinge area.

Repeat this process with the other wing panel, securely hinging the aileron in place.

After both ailerons are securely hinged, firmly grasp the wing panel and aileron to make sure the hinges are securely glued and cannot be pulled out. Do this by carefully applying medium pressure, trying to separate the aileron from the wing panel. Use caution not to crush the wing structure.

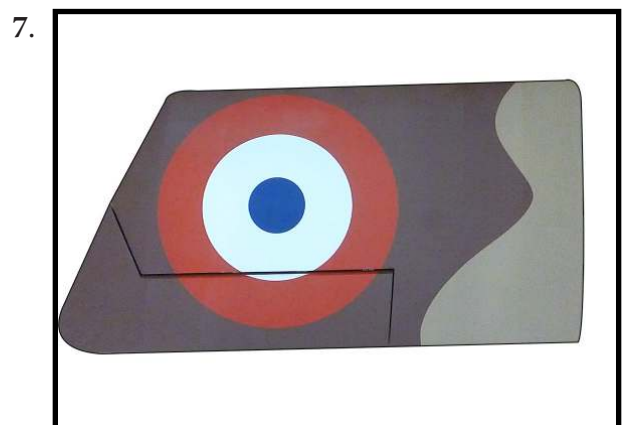

Note : Work the aileron up and down several times to “work in” the hinges and check for proper movement.

INSTALL THE AILERONS CONTROL HORN

Locate the aileron and flap control horns. The taller control horn is used for the ailerons, and the shorter horn for the flaps.

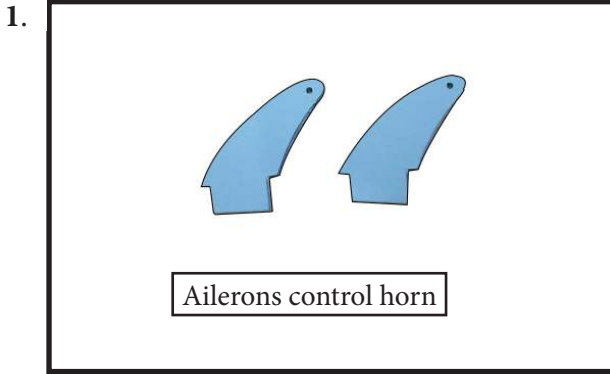

Use sandpaper to scuff the bottom of the aileron and flap control horns. Use a paper towel and isopropyl alcohol to remove any oils or debris from the control horns.

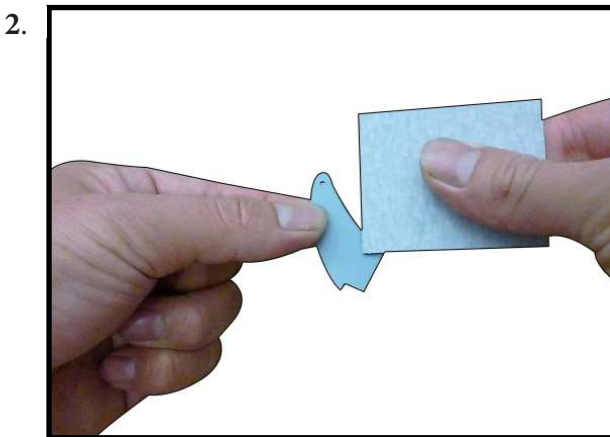

Check the fit of the control horns to the aileron and flap. They should rest flush against the control surface as shown.



Place low-tack tape 1/32 inch (1mm) from the control horn slot. This will prevent epoxy from getting on the control surface when the control horns are glued in place.

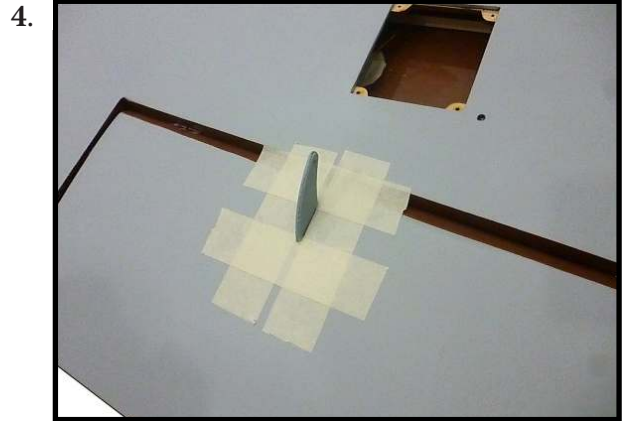

Remove the control horns from the control surfaces. Apply epoxy to the slot in the aileron and flap. Make sure the epoxy gets into the slot for a good bond between the surfaces and control horn.

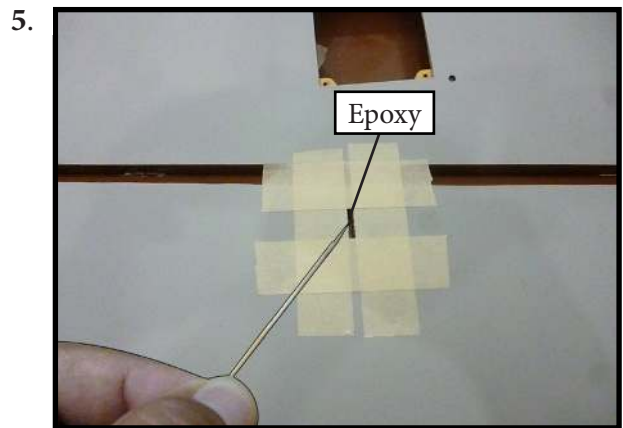

Apply epoxy to the area of the control horns that fit into the slots. Use enough epoxy so the control horns will be fully bonded to the fixed surfaces.

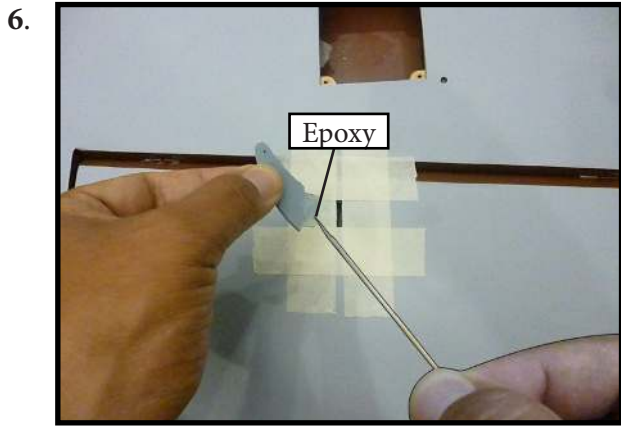

Before the epoxy fully cures, remove the tape from around the control horn. This will allow the epoxy to flow around the control horn, creating a small fillet between the control horn and surface for a finished look and secure bond.

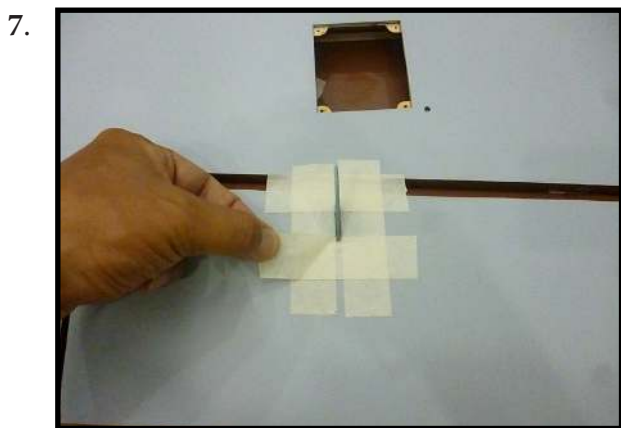

INSTALLING THE AILERON SERVOS

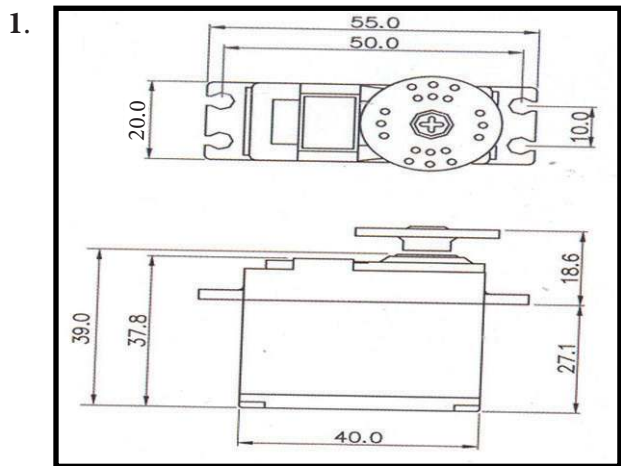

Minimum servo spec.
Torque : 6.0V: 157.00 oz-in (11.31 kg-cm)
 7.4V: 179.00 oz-in (12.89 kg-cm)

⚠ Because the size of servos differ, you may need to adjust the size of the precut opening in the mount. The notch in the sides of the mount allow the servo lead to pass through.

Place the servo between the mounting blocks and space it from the hatch. Use a pencil to mark the mounting hole locations on the blocks.

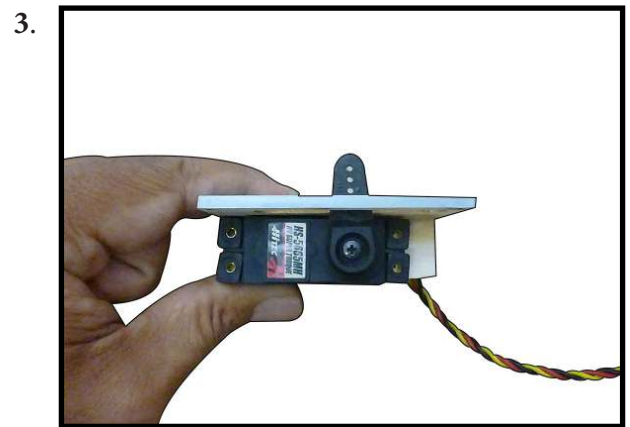

Use drill bit in a pin vise to drill the mounting holes in the blocks.

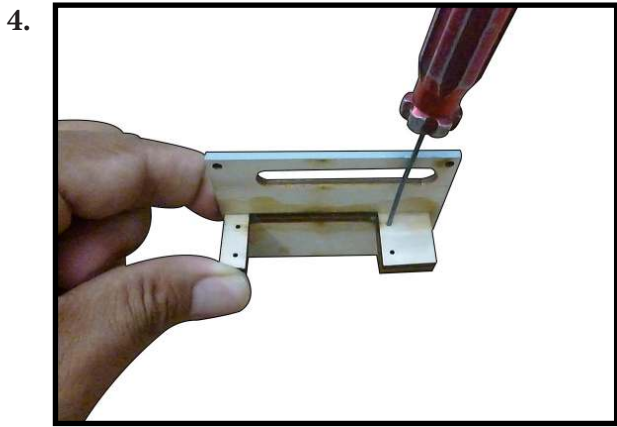

Apply 2-3 drops of thin C/A to each of the mounting holes. Allow the C/A to cure without using accelerator.

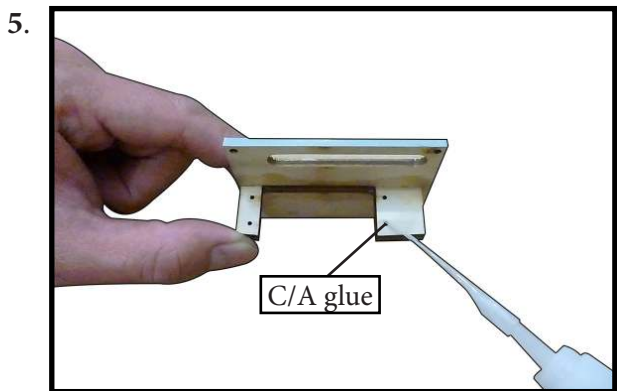

Use dental floss to secure the connection so they cannot become unplugged.

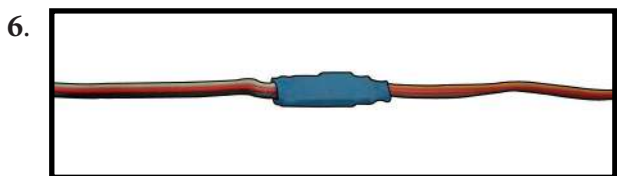

Secure the servo to the aileron hatch using Phillips screwdriver and the screws provided with the servo.

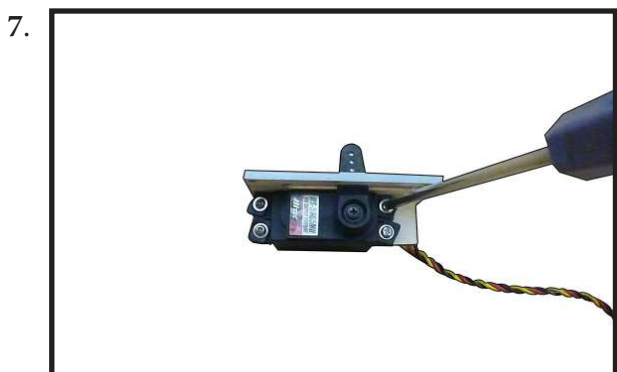

Apply 1-2 drops of thin C/A to each of the mounting tabs. Allow the C/A to cure without using accelerator.

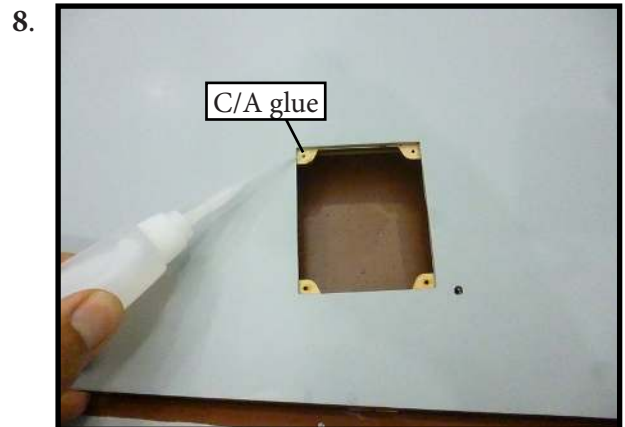

Remove the string from the wing at the servo location and use the tape to attach it to the servo extension lead. Pull the lead through the wing and remove the string.

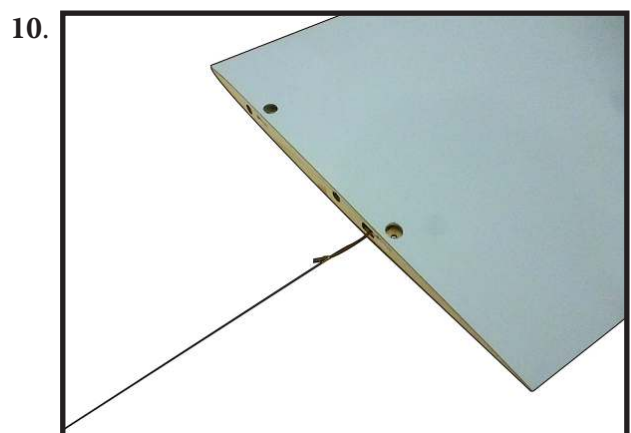
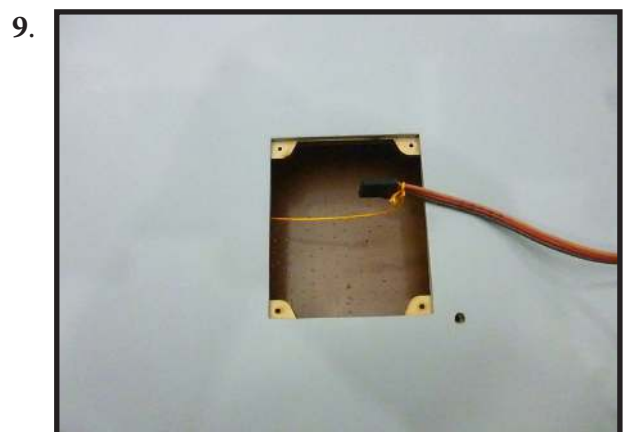

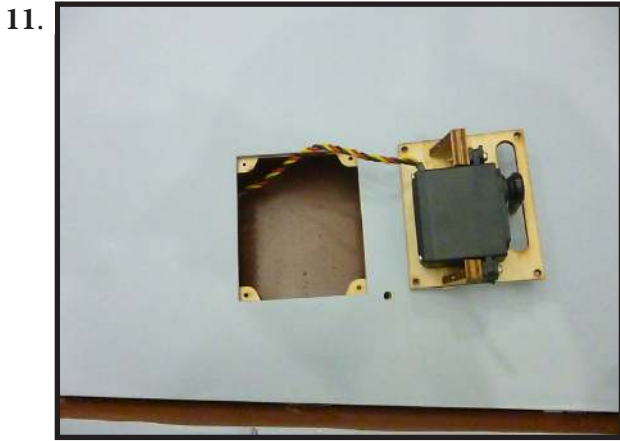

Set the aileron hatch in place and use a Phillips screw driver to install it with four wood screws.

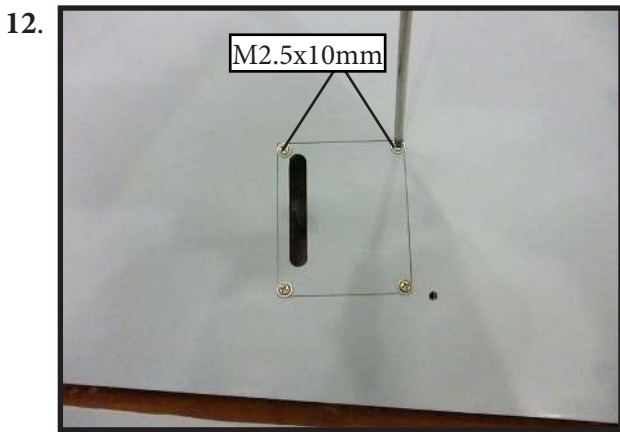

AILERON PUSHROD INSTALLATION

Please study images below.

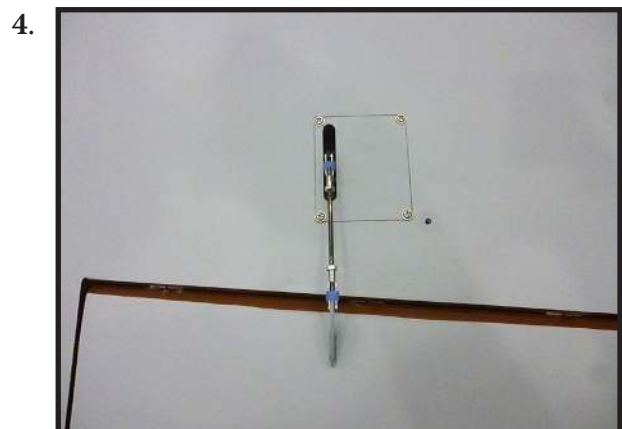
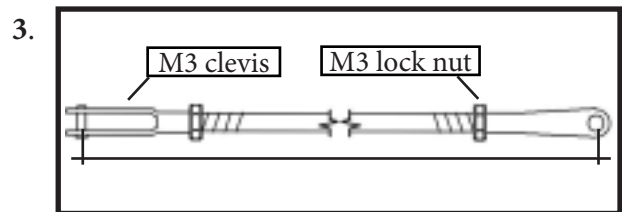
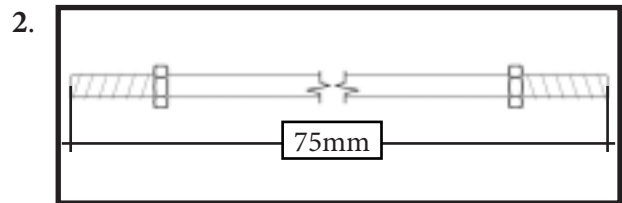
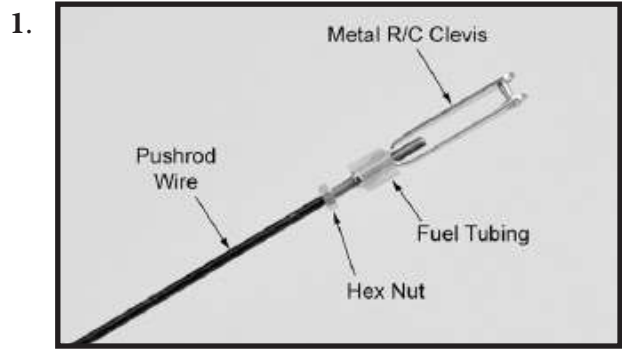

INSTALLING THE FUSELAGE SERVOS

! Because the size of servos differ, you may need to adjust the size of the precut opening in the mount. The notch in the sides of the mount allow the servo lead to pass through.

Install the rubber grommets and brass collets into all servos. Test fit the servos into the fuselage servo mounts.

Secure the servos with the screws provided with your radio system.

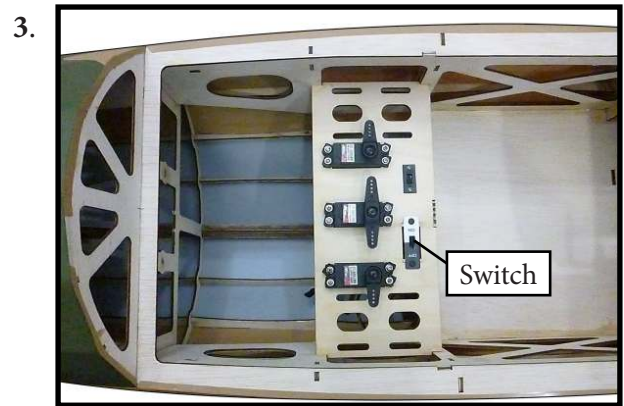
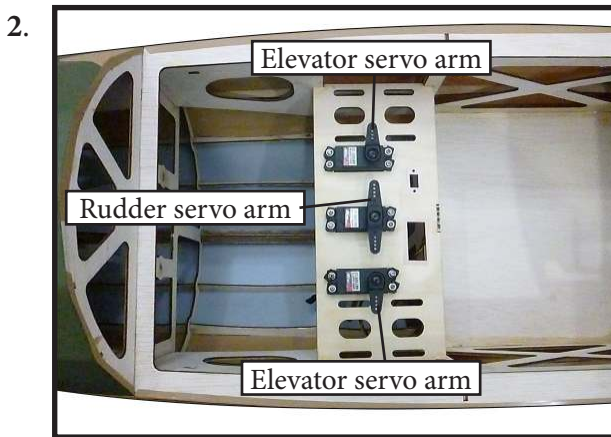
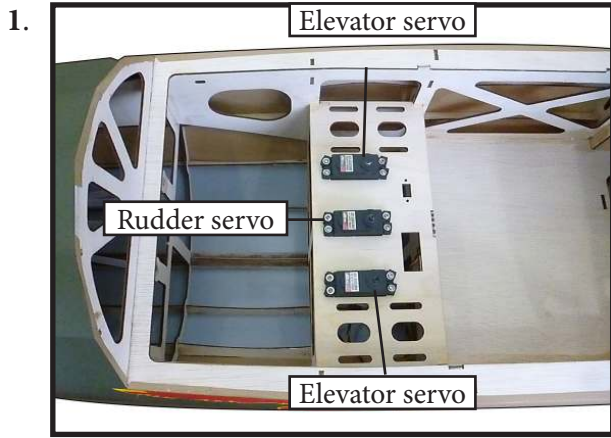

Minimum servo spec.
Torque : 6.0V: 157.00 oz-in (11.31 kg-cm)
 7.4V: 179.00 oz-in (12.89 kg-cm)

INSTALLING THE MAIN LANDING GEAR TO FUSELAGE

Please study images below.

INSTALLING THE ENGINE SWITCH

Insert the switch into the pre-cut hole in the fuselage

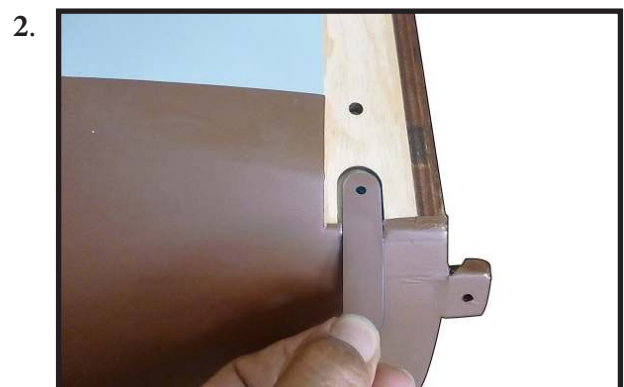
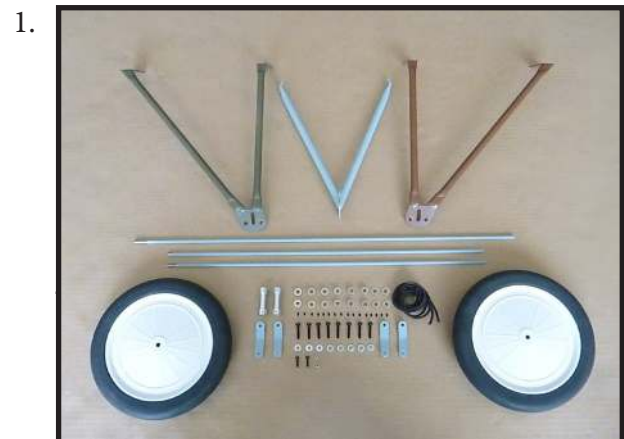
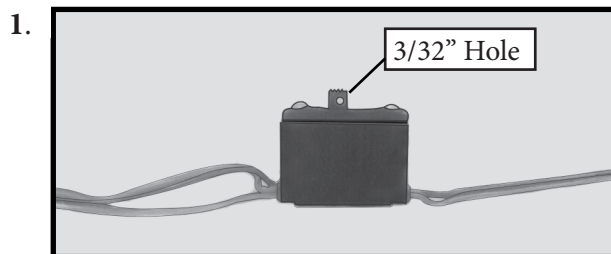

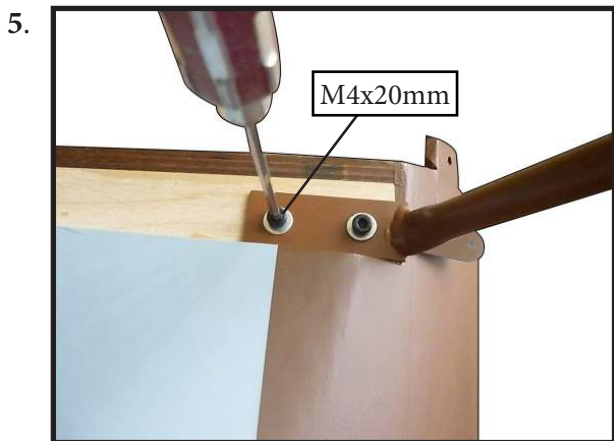
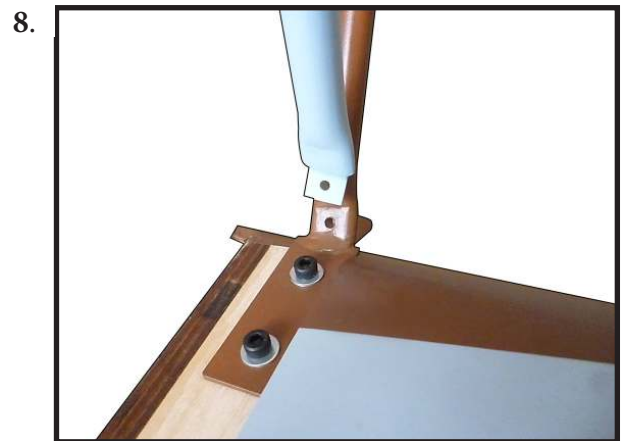
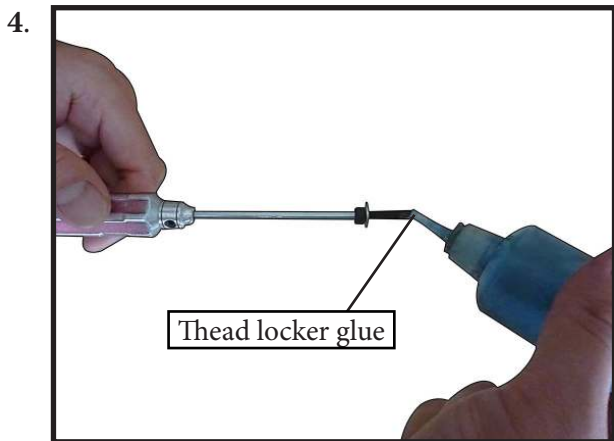
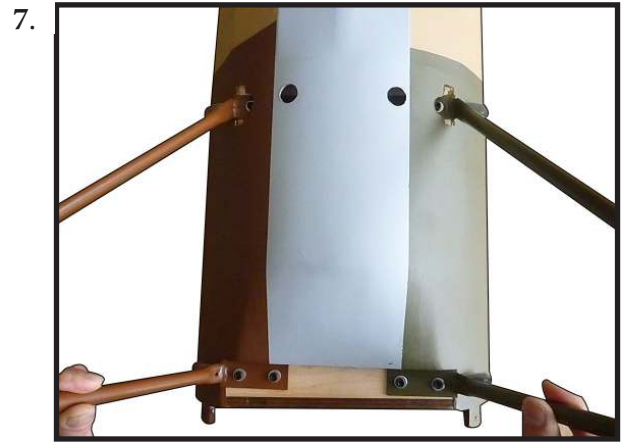
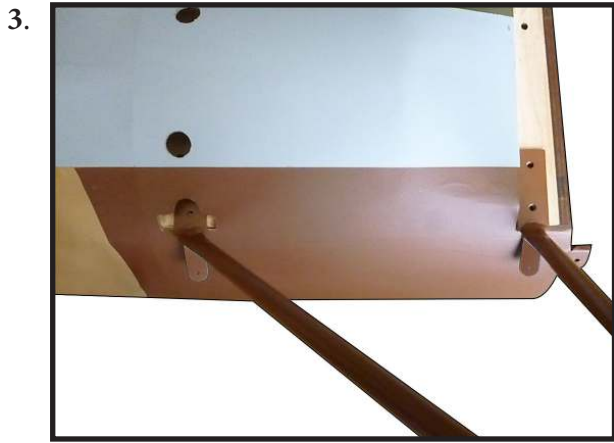

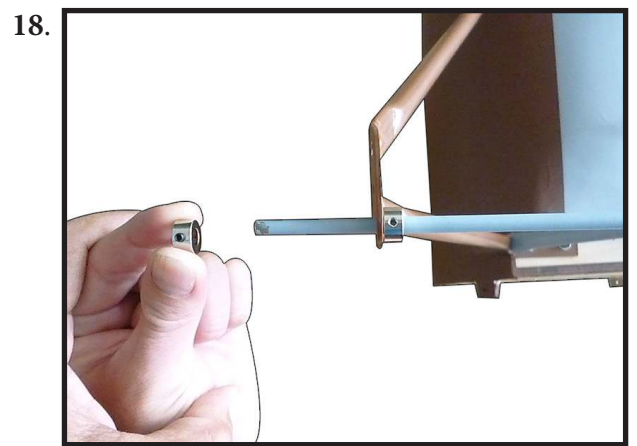
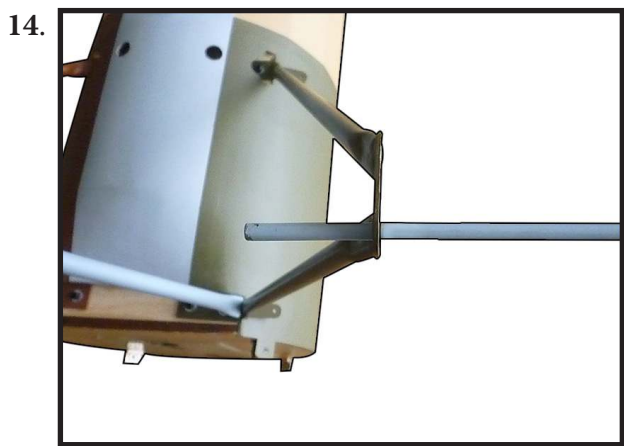
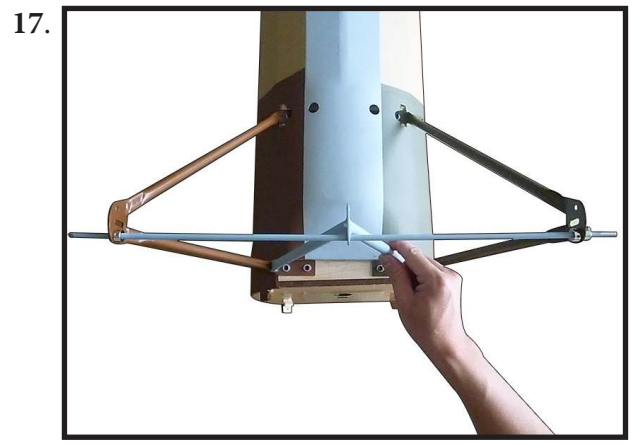
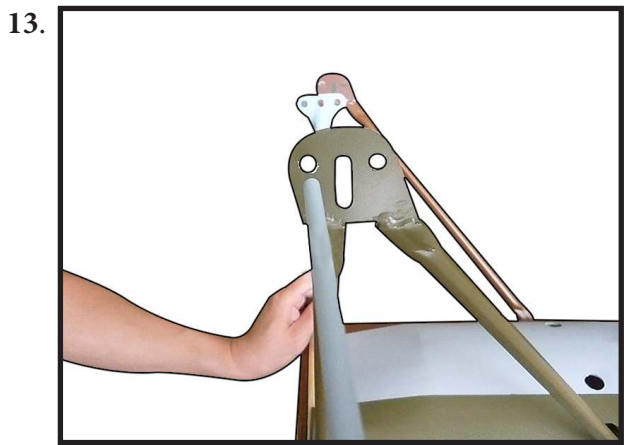
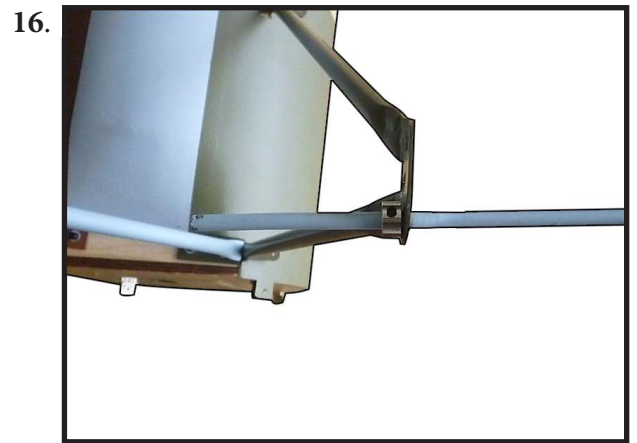
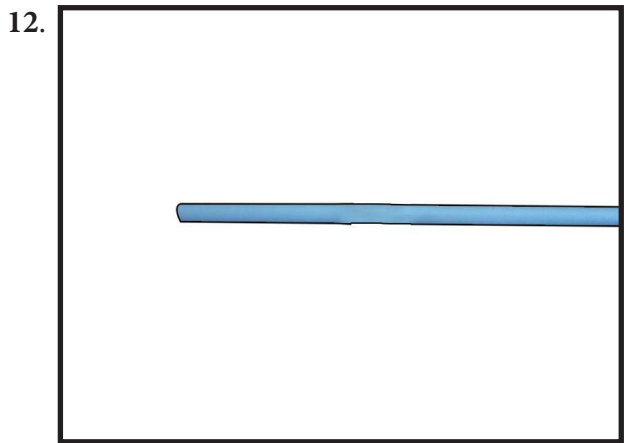
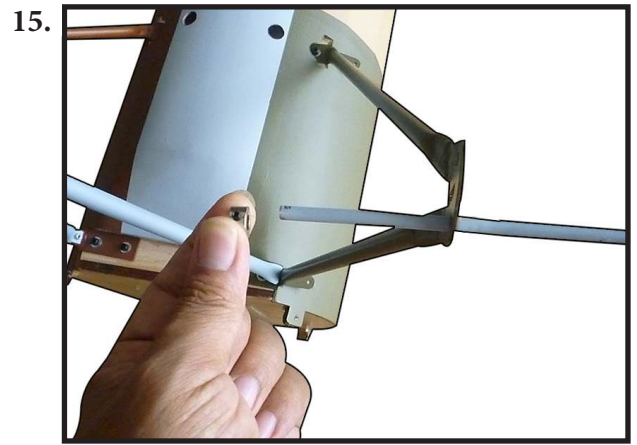
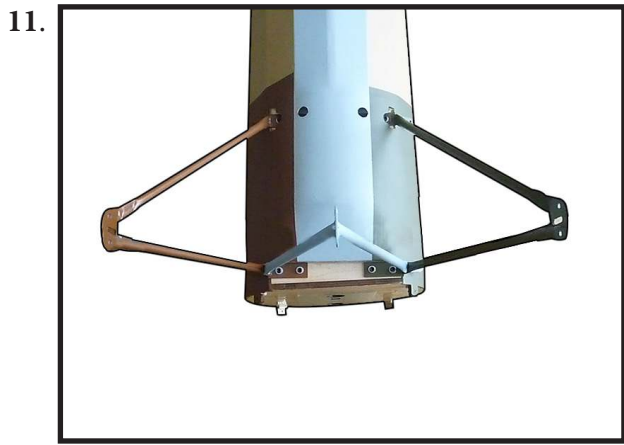

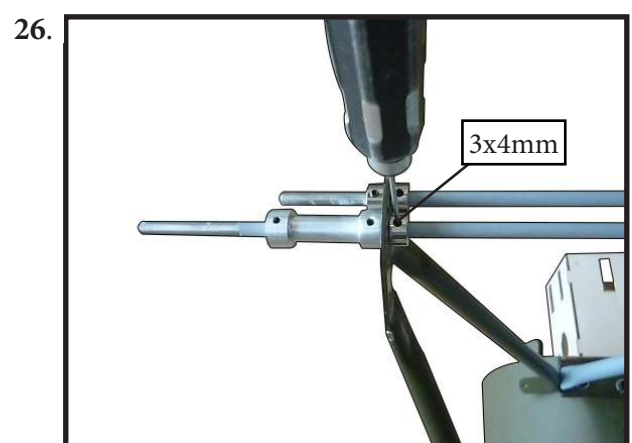
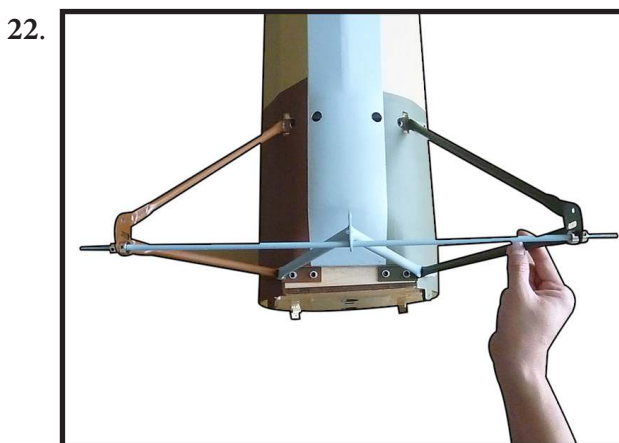
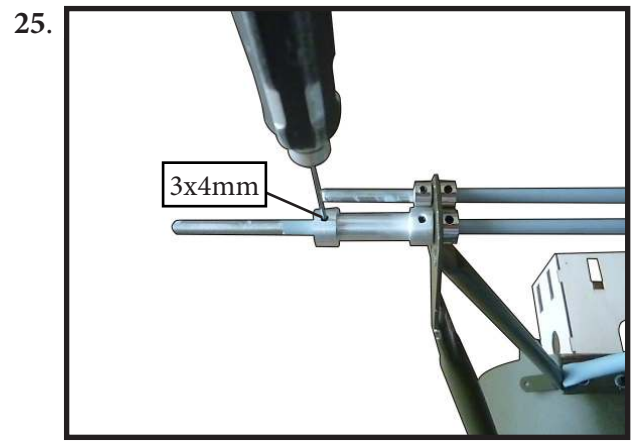
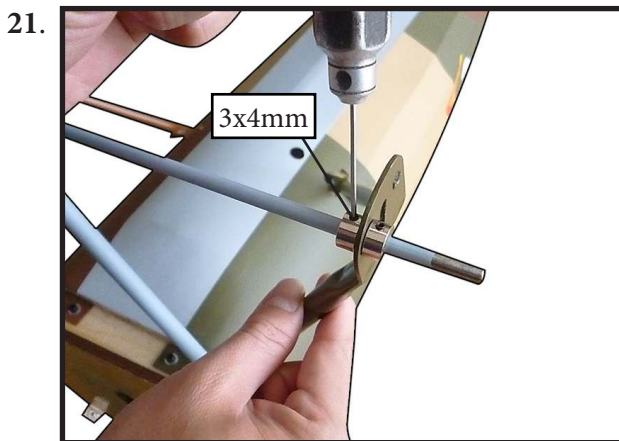
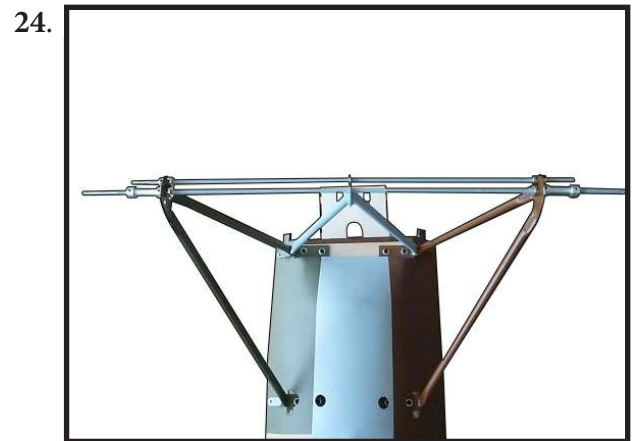
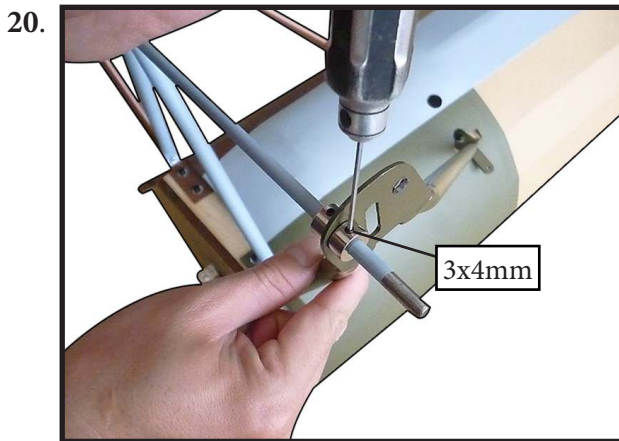
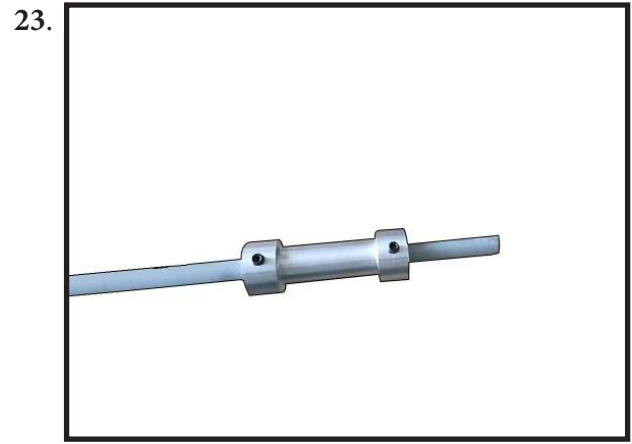
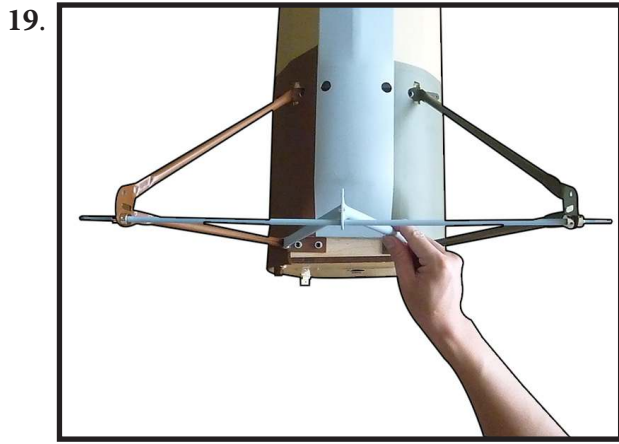

27.

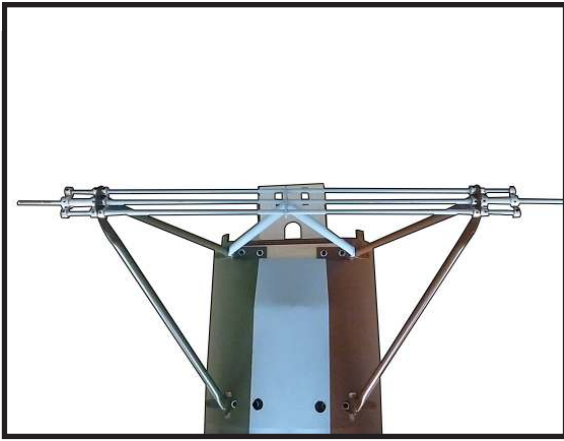

Tie the shock cord to the rear axle support. Leave 1/2-inch (13mm) of shock cord outside the knot so the opposite end of the shock cord can be secure to it.

28.

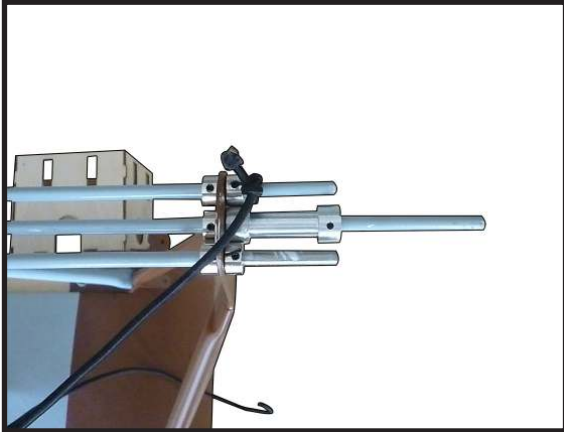

Wrap the shock cord under the shock cord collar on the main axle and under the forward axle support.

29.



Loop the cord over the forward axle support, under the shock cord collar, then over the rear axle support.

30.

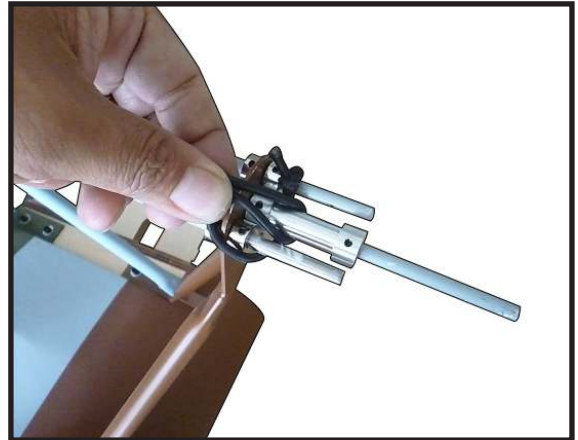

Wrap the cord back around the rear axle support. Continue to wrap the shock cord six times around all the supports for the landing gear.

Use hemostats to aid in routing the shock cord.

The amount of tension that is applied to the shock cord while being pulled around the axle determines the suspension rate/strength. Various tension rates have been tested on this aircraft. It was found almost no tension while installing the shock cord was a little soft for anything other than very smooth ground. A moderate amount of tension while wrapping the shock cord seems ideal. When applying hand pressure to the main axle it may appear difficult to get the axle to move up and down against the tension of the shock cord and seem too stiff. When the model is on its wheels and fully loaded each axle moved freely and easily. We suggest cable ties to secure as it allows later adjustment of the shock cord.

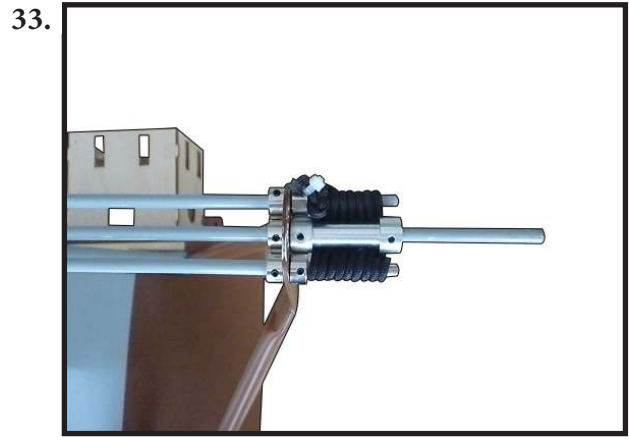
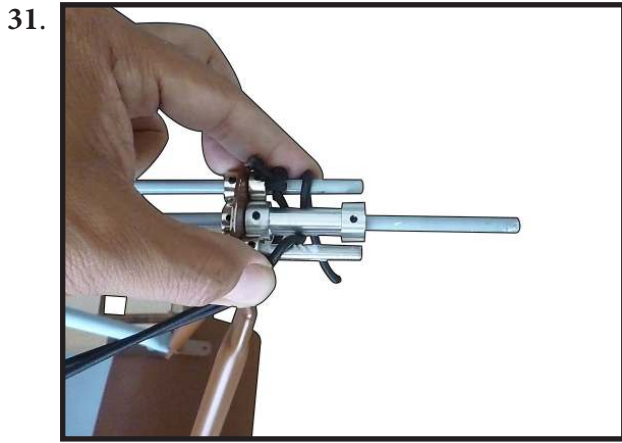

Use a tie wrap to secure the shock cord ends together. Use hemostats to hold the shock cord while installing the tie wrap.

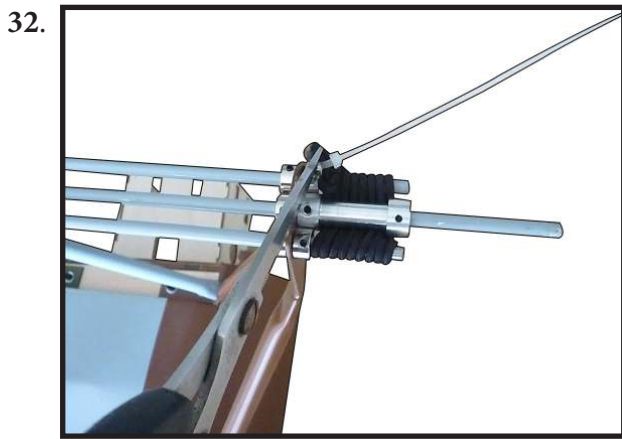
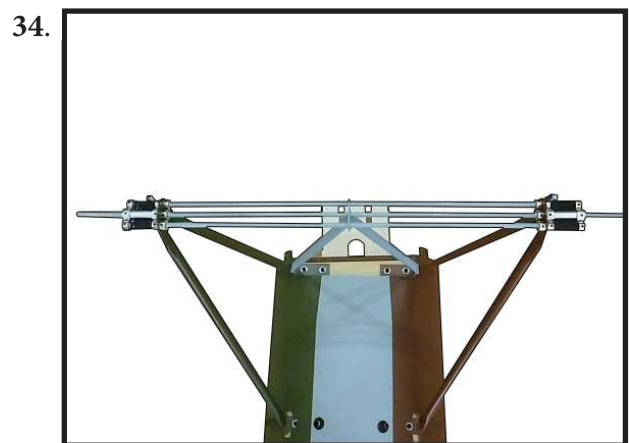

Cut the excess of the tie wrap so the landing gear wing cover can be installed. When the shock cord is installed, it will fit inside the landing gear wing and will not interfere with the installation of the cover. Tighten all the hardware associated with the landing gear at this time.

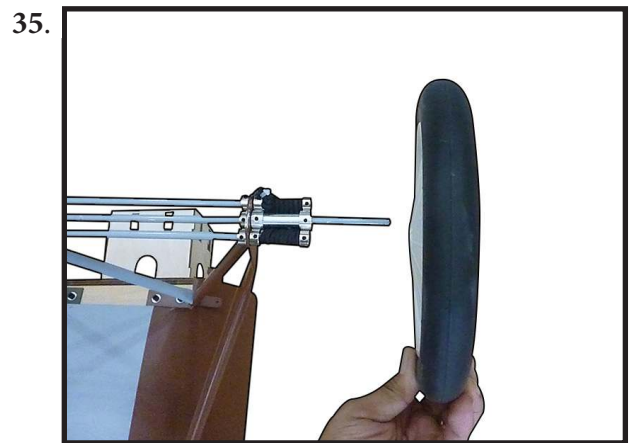

Repeat the previous steps to install the remaining main axle and shock cord.



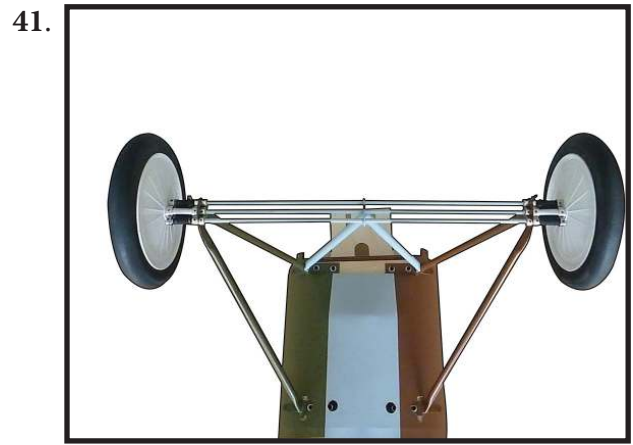
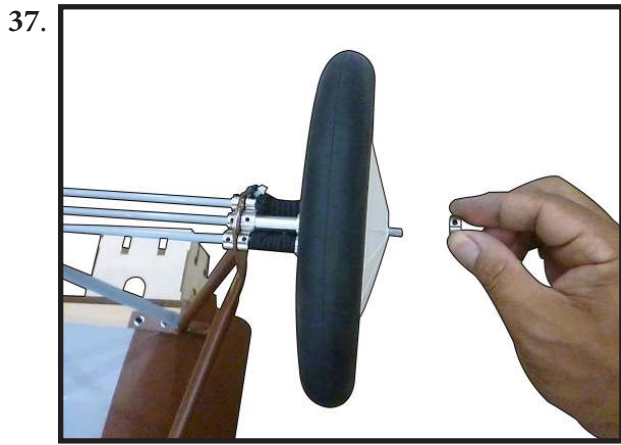

INSTALLING THE STOPPER ASSEMBLY

Using a modeling knife, carefully cut off the rear portion of one of the 3 nylon tubes leaving 1/2" protruding from the rear of the stopper. This will be the fuel pick up tube.

Using a modeling knife, cut one length of silicon fuel line. Connect one end of the line to the weighted fuel pick up and the other end to the nylon pick up tube.

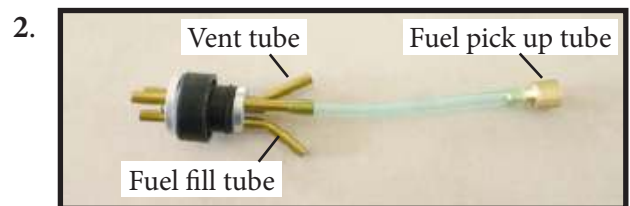
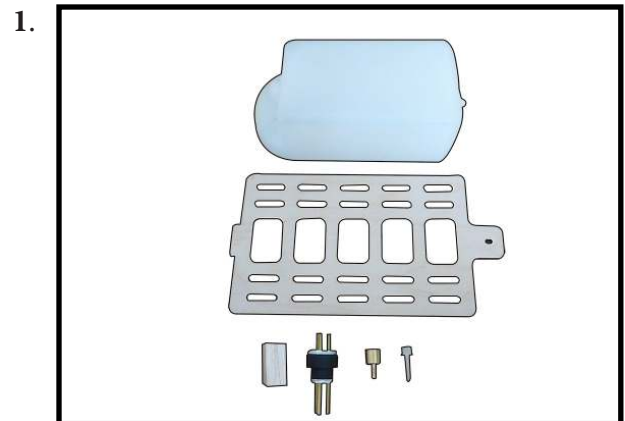

Carefully bend the second nylon tube up at a 45° angle. This tube is the vent tube.

Test fit the stopper assembly into the tank. It may be necessary to remove some of the flashing around the tank opening using a modeling knife. If flashing is present, make sure none falls into the tank.

With the stopper assembly in place, the weighted pick-up should rest away from the rear of the tank and move freely inside the tank. The top of the vent tube should rest just below the top of the tank. It should not touch the top of the tank.

When satisfied with the alignment of the stopper assembly tighten the 3 x 20mm machine screw until the rubber stopper expands and seals the tank opening. Do not overtighten the assembly as this could cause the tank to split.

FUEL TANK INSTALLATION

1.

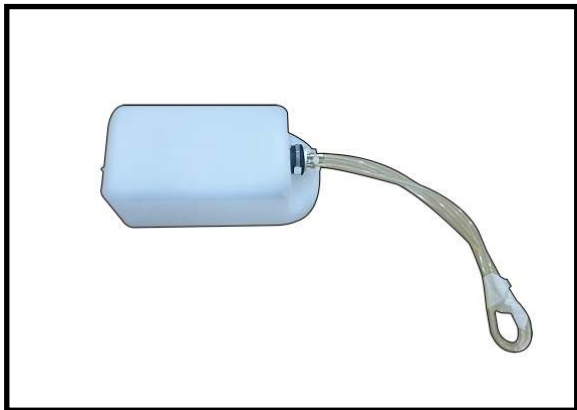

⚠ *You should mark which tube is the vent and which is the fuel pickup when you attach fuel tubing to the tubes in the stopper. Once the tank is installed inside the fuselage, it may be difficult to determine which is which.*

2.



3.

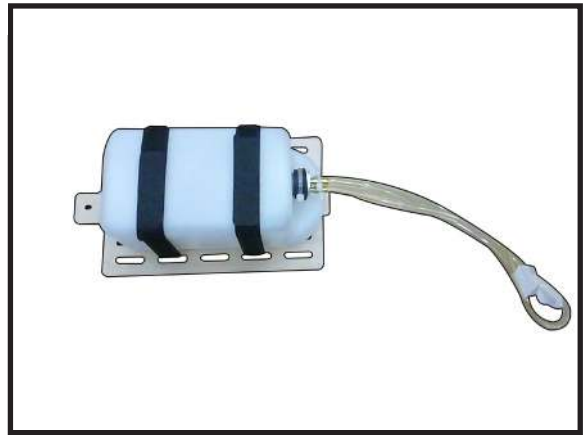

4.

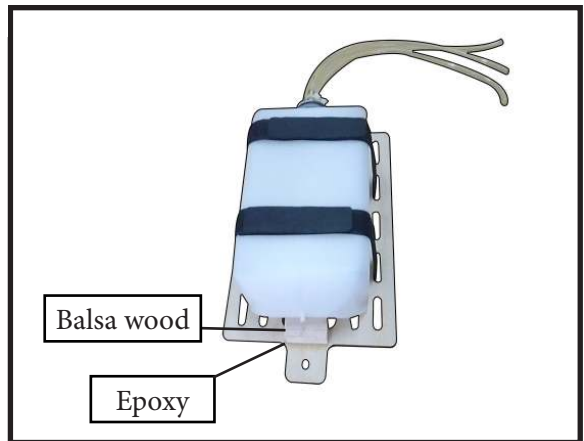

Slide the fuel tank into the fuselage. Guide the lines from the tank through the hole in the firewall.

5.

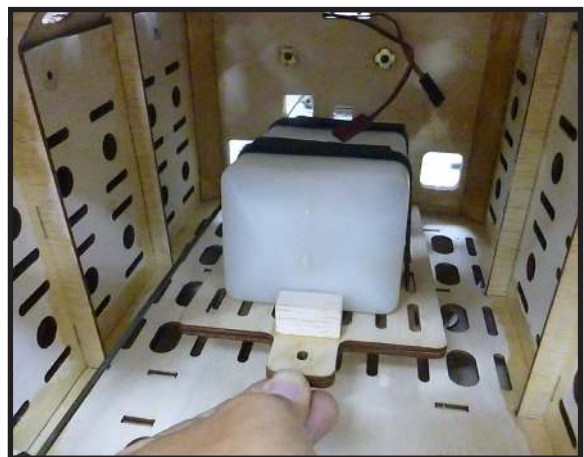

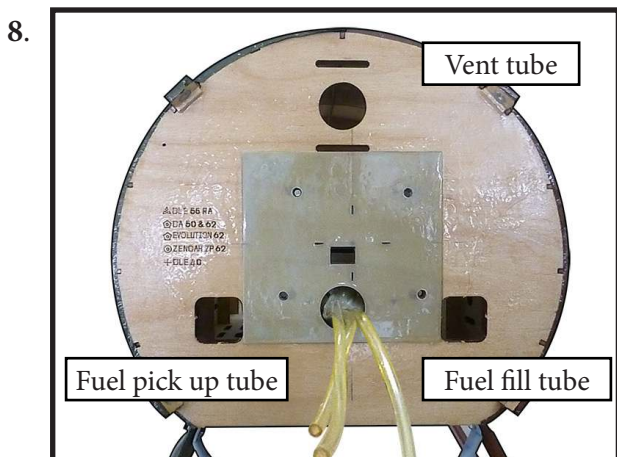
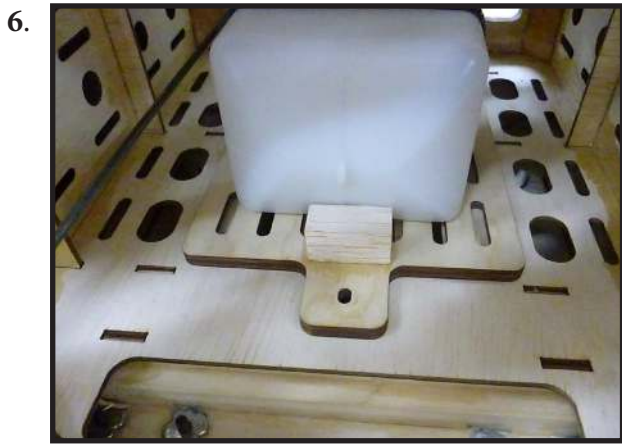

Connect the lines from the tank to the engine and muffler. The vent line will connect to the muffler and the line from the clunk to the carburetor.

 **Blow through one of the lines to ensure the fuel lines have not become kinked inside the fuel tank compartment. Air should flow through easily.**

MOUNTING THE ENGINE

Please study images below.



Locate the engine mounting in position on the firewall. Use a 2.5mm drill bit to drill the holes necessary to mount your particular motor choice.

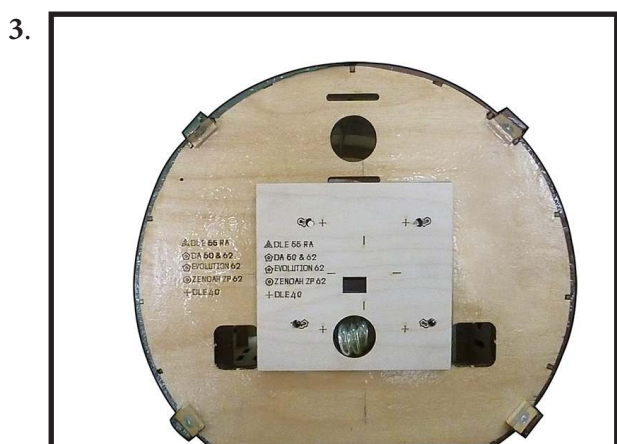
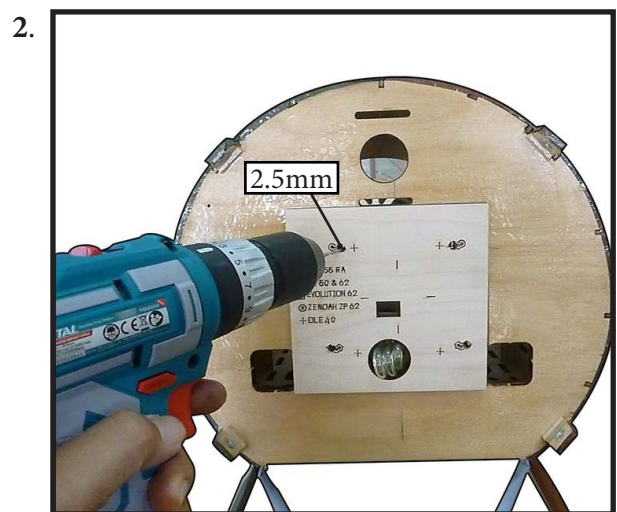

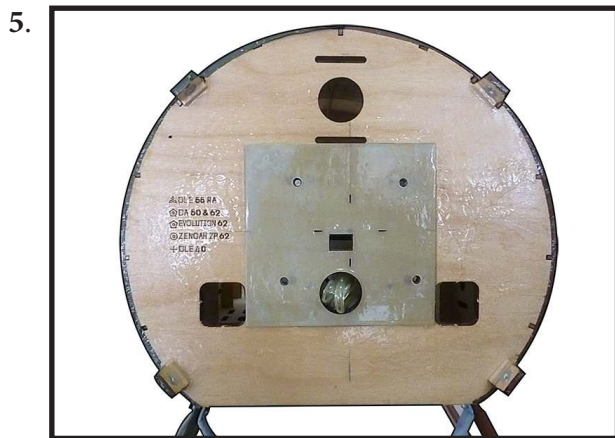
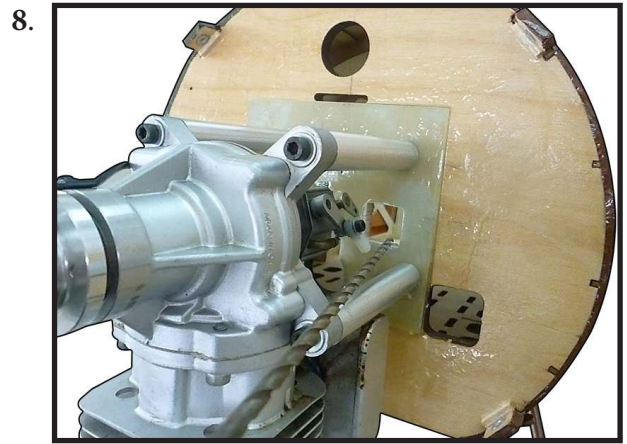
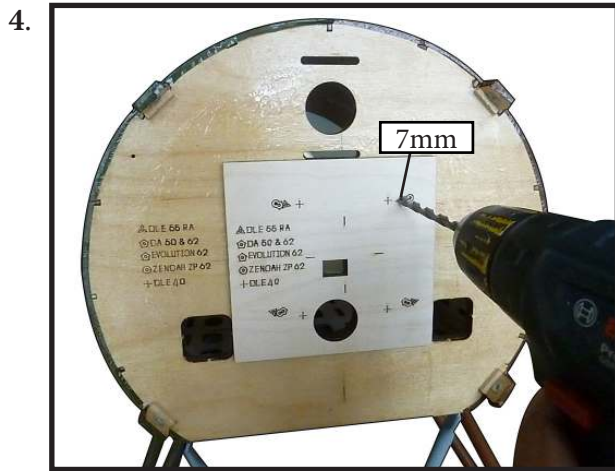

Position the engine with the drive washer (197mm) forward of the firewall.

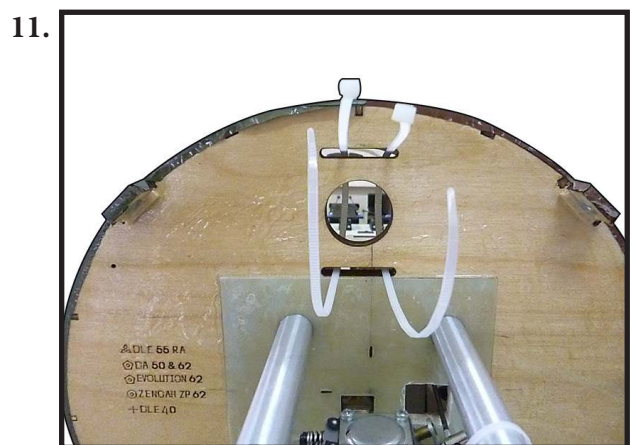
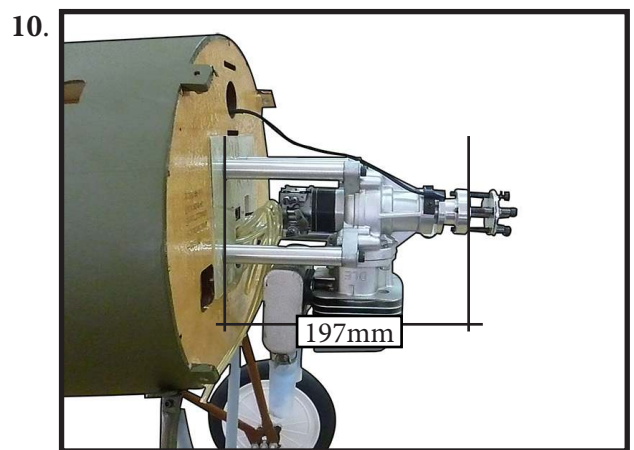

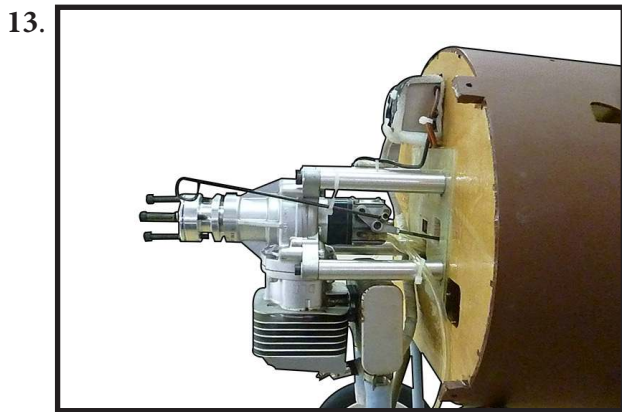
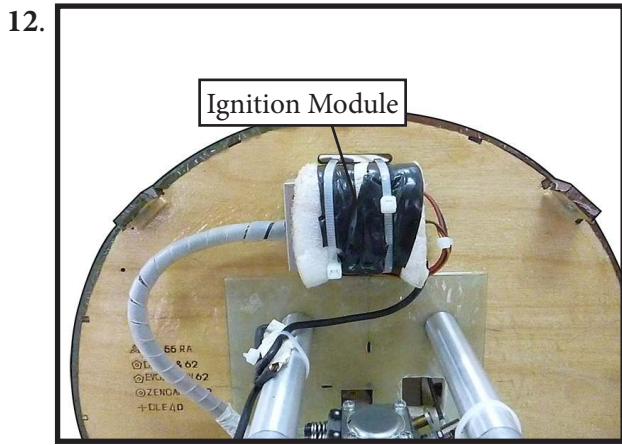

Attach the muffler to the engine using the hardware included with the muffler.

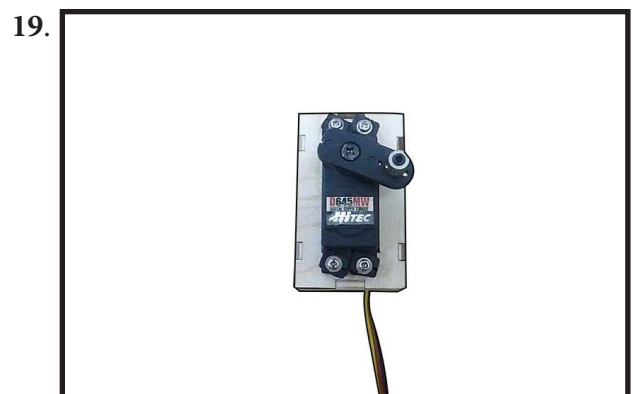
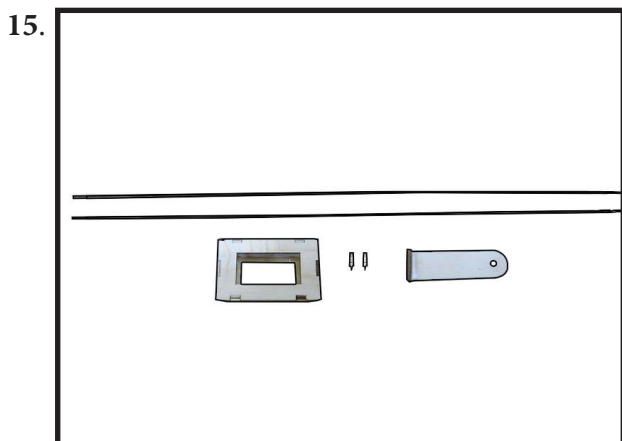
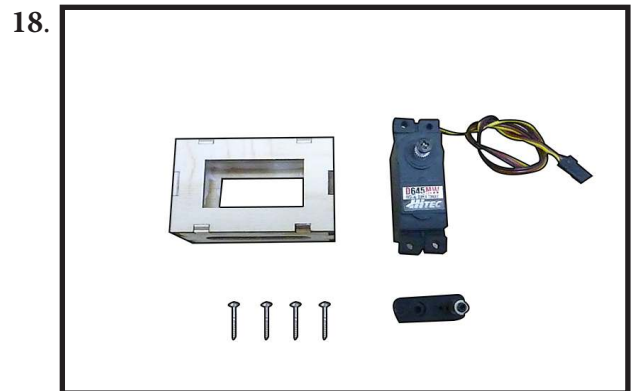
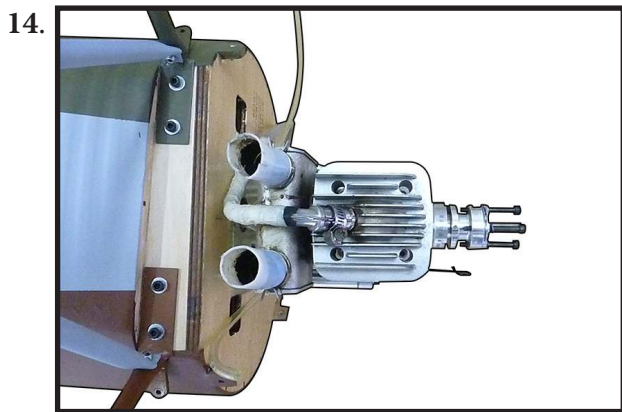

Use epoxy glue to attach the push base to the inside of the fuselage and propeller.

20.

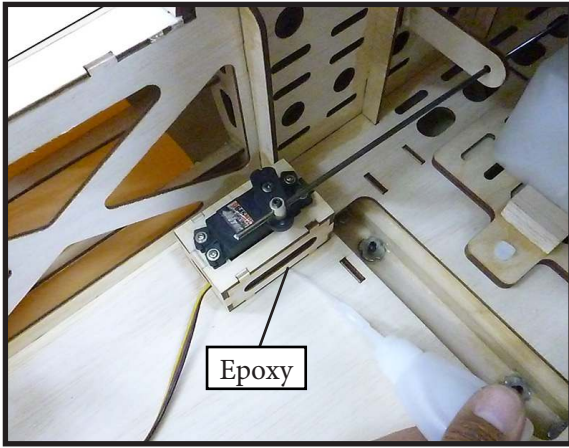

Reinstall the servo horn by sliding the connector over the pushrod wire. Center the throttle stick and trim and install the servo horn perpendicular to the servo center line.

21.

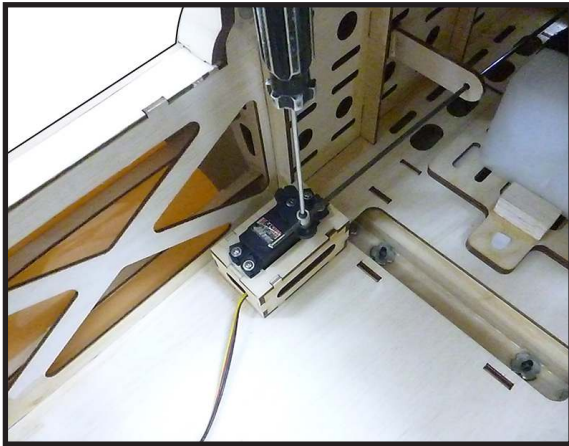

Move the throttle stick to the closed position and move the carburetor to closed.

Use a 2.5mm hex wrench to tighten the screw that secures the throttle pushrod wire. Make sure to use threadlock on the screw so it does not vibrate loose.

22.

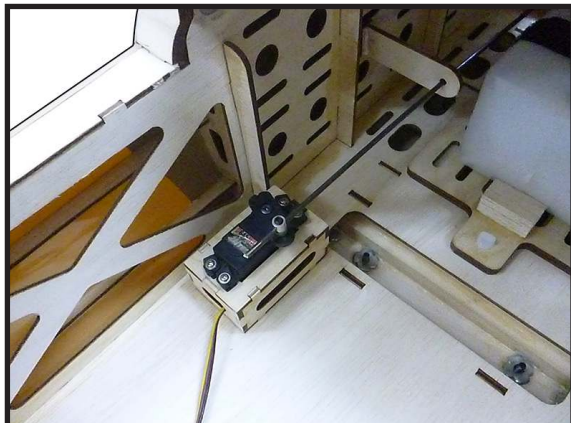

COWLING

Please study images below.

1.

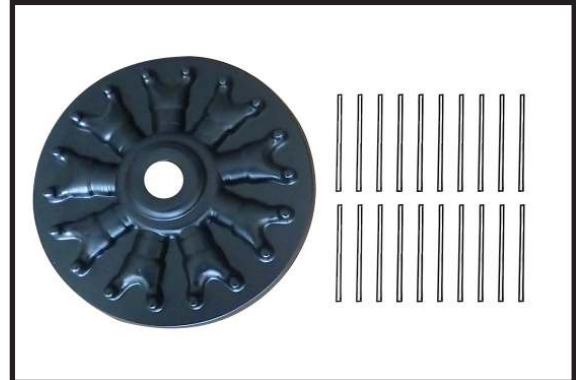

2.

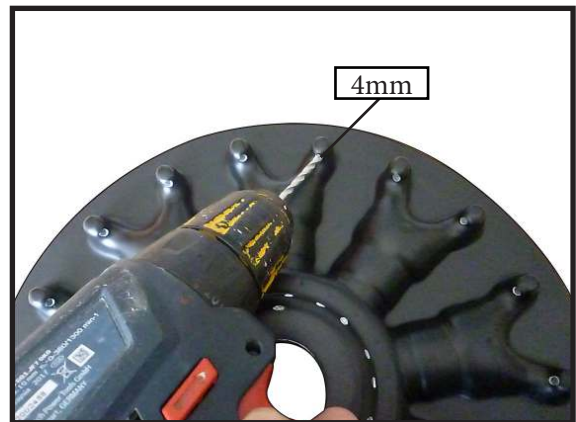

3.



4.



5.



9.



6.



10.



7.



11.



8.



12.





Tape the cowl to the fuselage using low-tack tape.

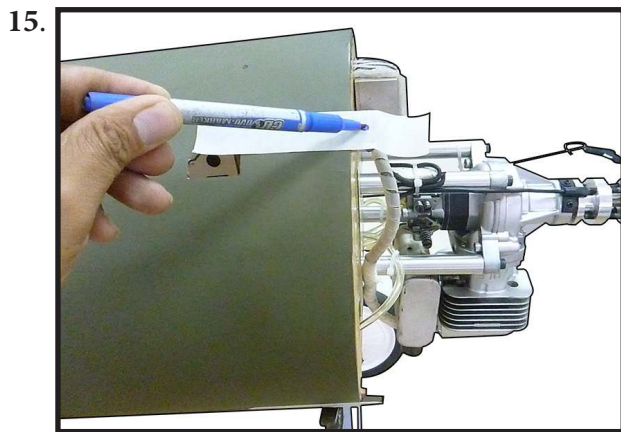

Use a drill and drill bit to drill the holes for the cowl mounting screws. Make sure the cowl position is correct before drilling each hole.

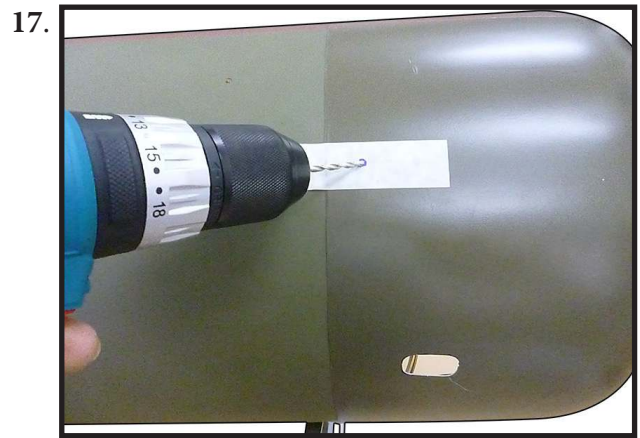

Install the muffler and muffler extension onto the engine and make the cutout in the cowl for muffler clearance. Connect the fuel and pressure lines to the carburetor, muffler and fuel filter valve. Secure the cowl to fuselage using the M3x10mm socket head screws. Putting a small length of silicon fuel tube under the head of the screw helps with vibration.

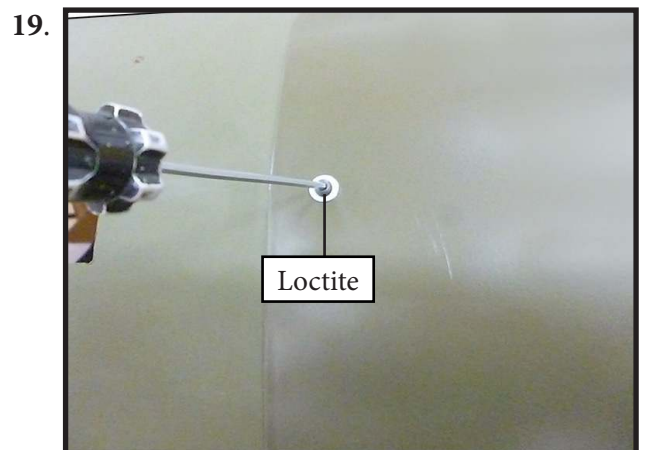
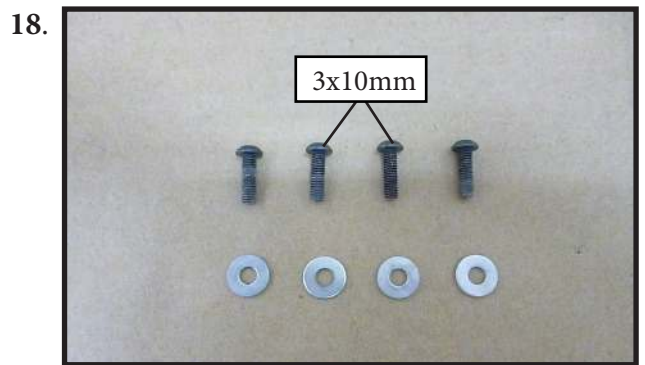

20.



21.

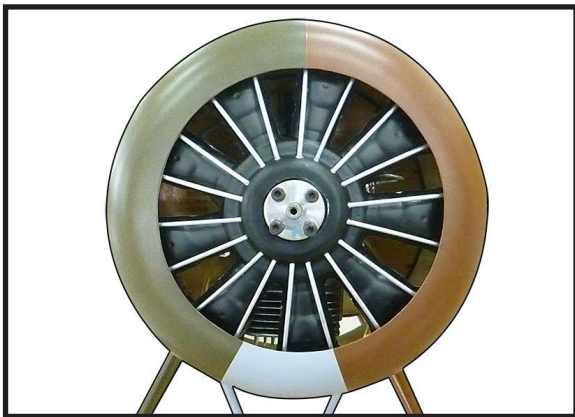

22.

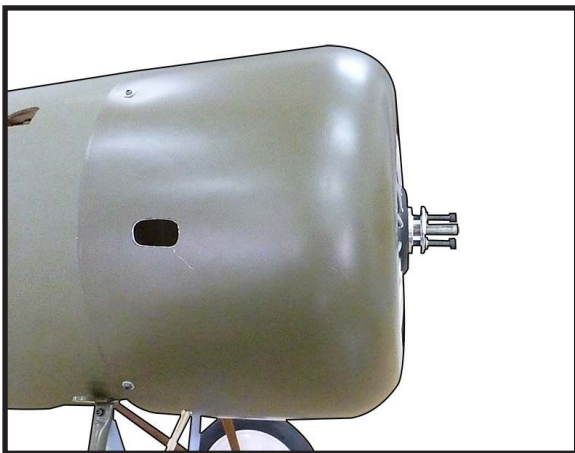

23.

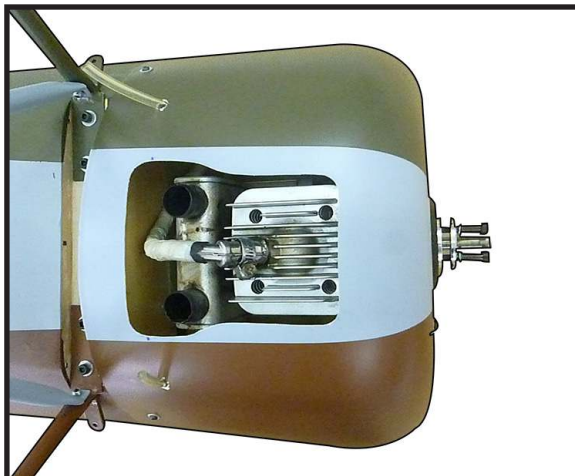

ELECTRIC POWER CONVERSION

Locate the items necessary to install the electric power conversion included with your model.

1.

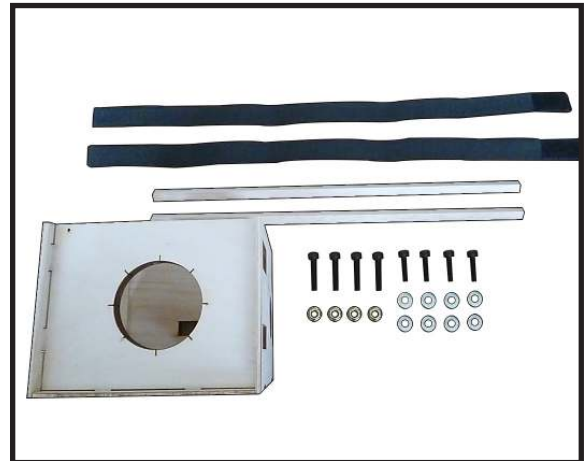

Recommend the items necessary to install the electric power conversion parts included with your model.

- **Motor: 360 - 6000 Watts**

- **Propeller: 24x10 ~ 26x8**

- **ESC: 160A - 200A**

- **12S Lipo**

Locate the engine mounting in position on the firewall. Use a 5mm drill bit to drill the holes necessary to mount your particular motor choice.

2.

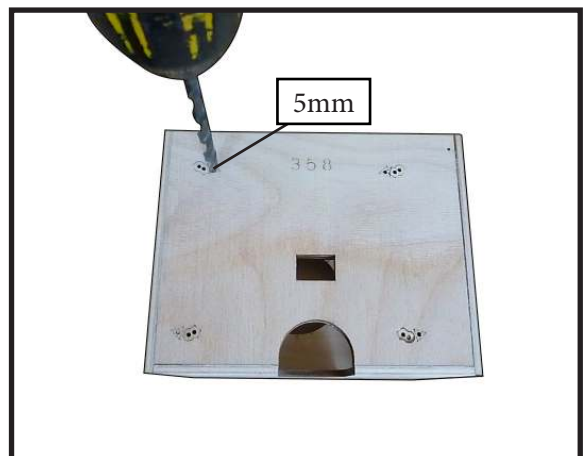

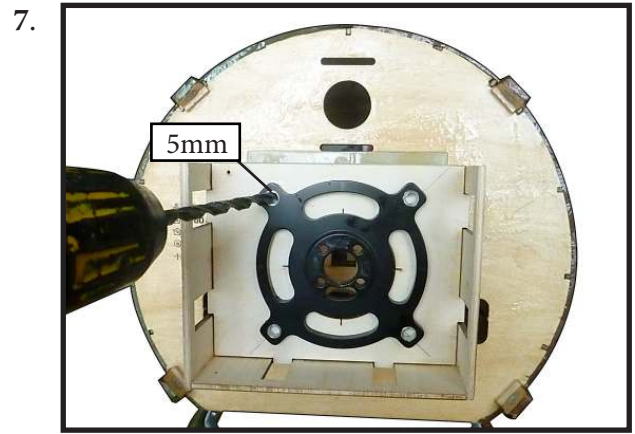
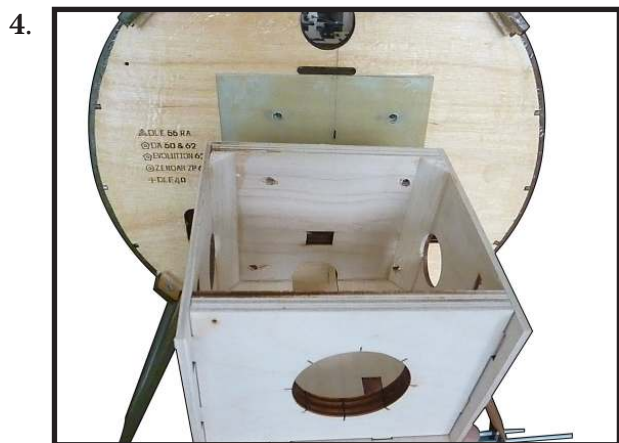

Then, use 5mm drill bit to enlarge the holes on the electric motor box.

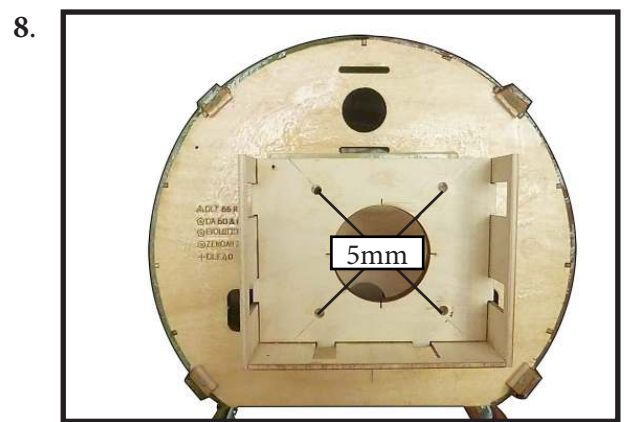

Attach the motor mount to the front of the electric motor box using four 5mm blind nut, four M5x20mm hex head bolts to secure the motor. Please see picture shown.

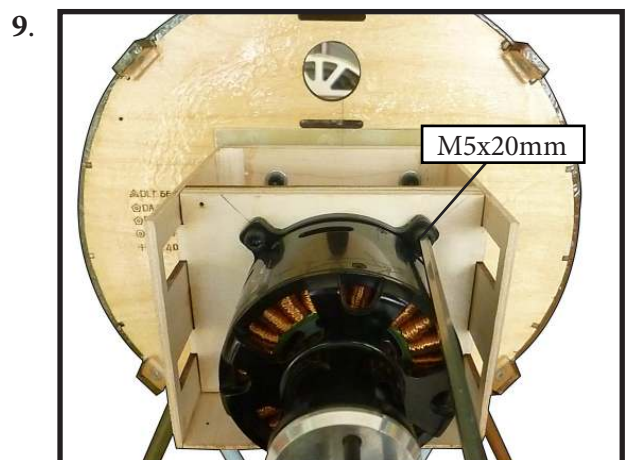

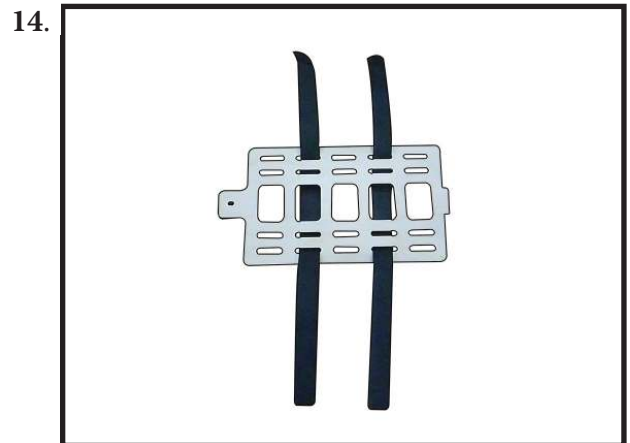
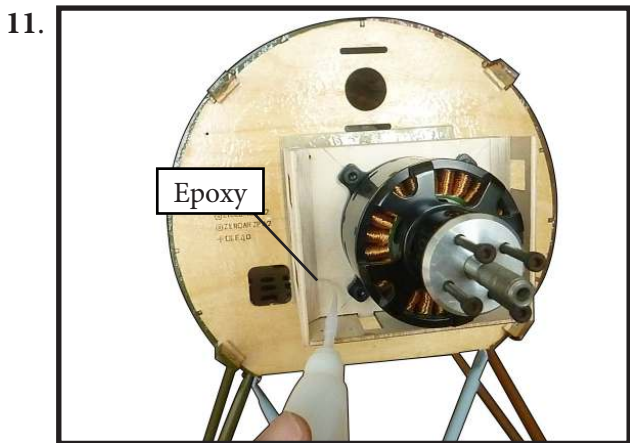
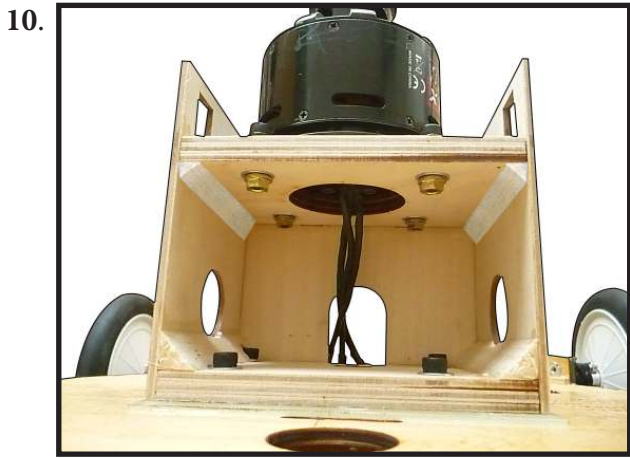

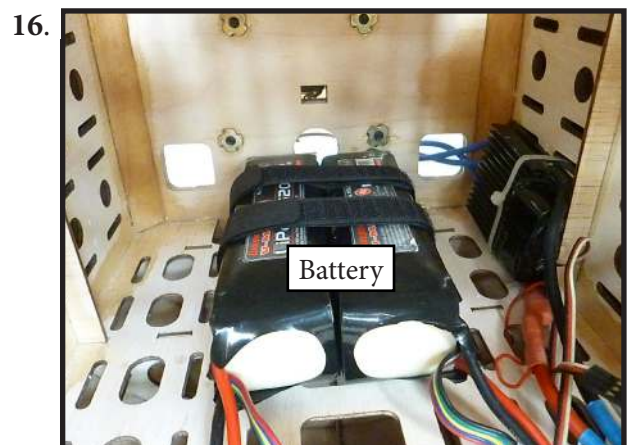
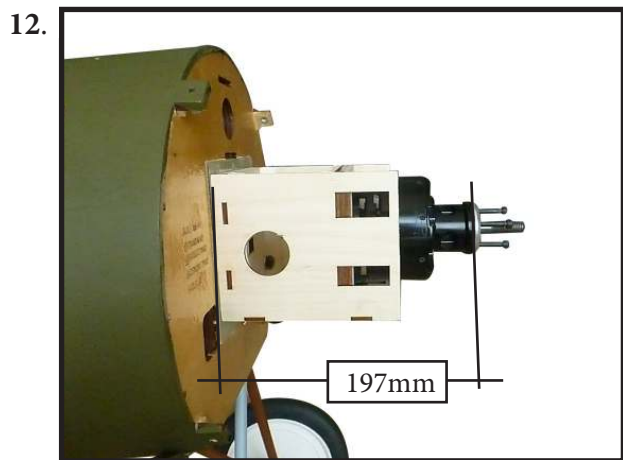
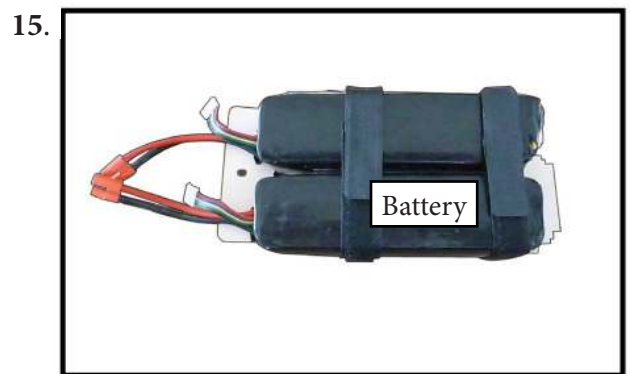

Attach the speed control to the side of the motor box using two-sided tape and tie wraps. Connect the appropriate leads from the speed control to the motor. Make sure the leads will not interfere with the operation of the motor.

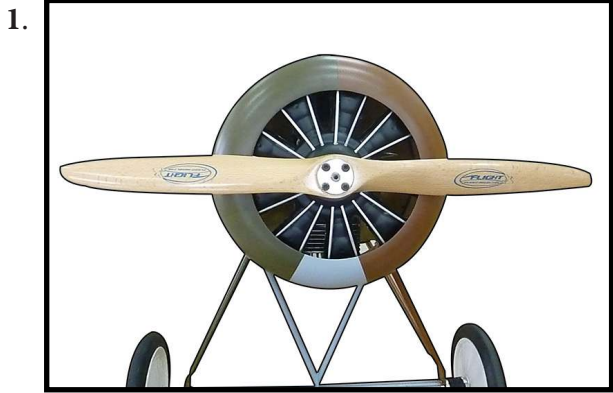

INSTALLING THE SPINNER

Install the spinner backplate, propeller and spinner cone.



 The propeller should not touch any part of the spinner cone. If it does, use a sharp modeling knife and carefully trim away the spinner cone where the propeller comes in contact with it.

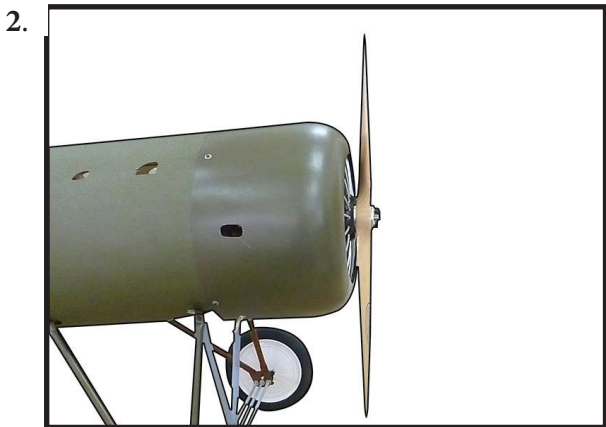

HINGING THE ELEVATORS

Glue the elevator hinges in place using the same techniques used to hinge the ailerons.

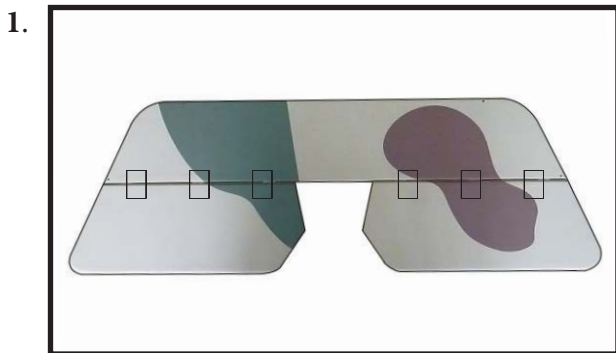

INSTALL ELEVATOR CONTROL HORN

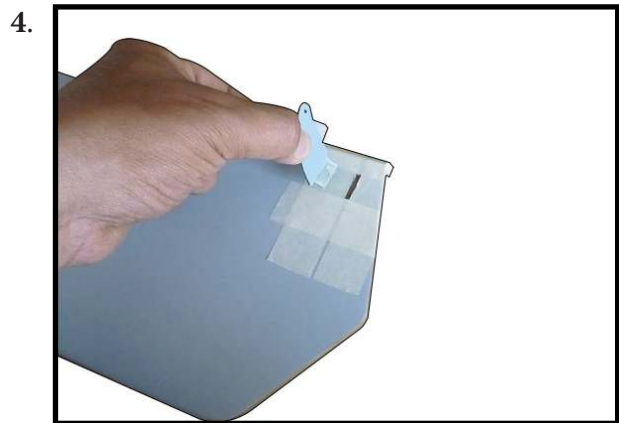
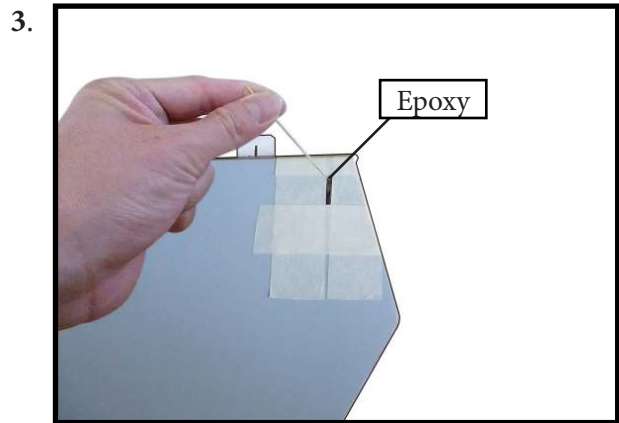
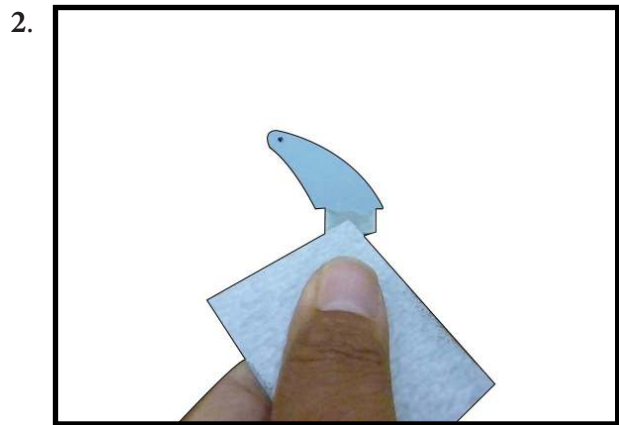
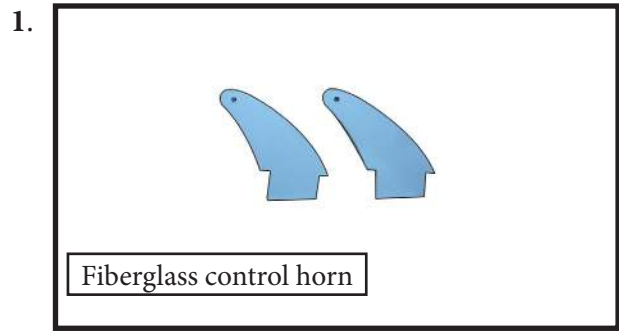

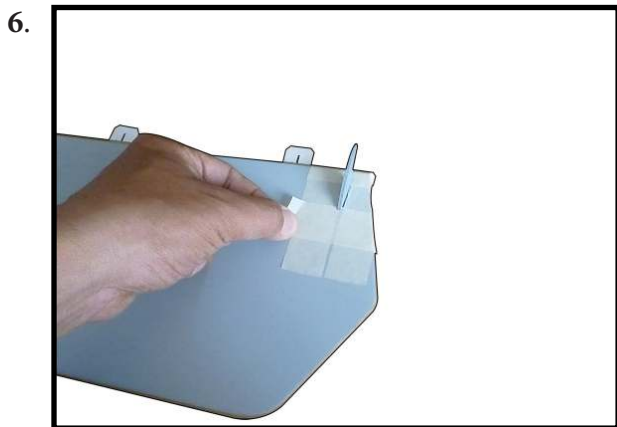
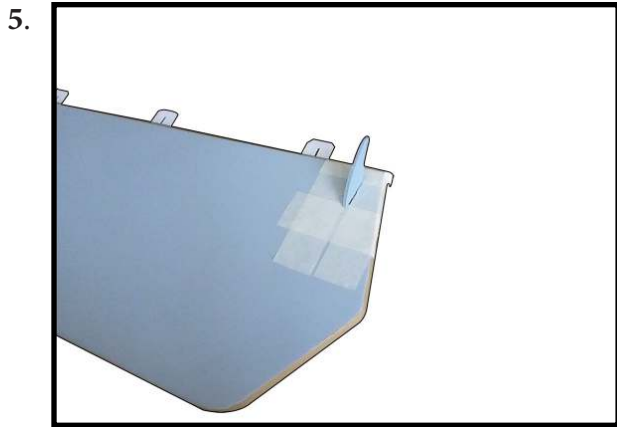

**ELEVATOR AND STABILIZER
INSTALLATION**

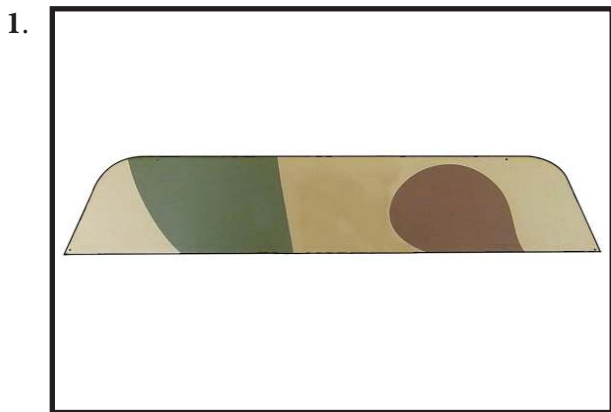

With the stabilizer held firmly in place, use a pen and draw lines onto the stabilizer where it and the fuselage sides meet. Do this on both the right and left sides and top and bottom of the stabilizer.

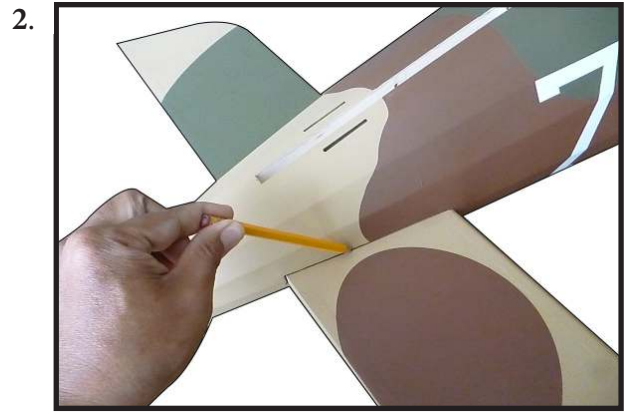

Remove the stabilizer. Using the lines you just drew as a guide, carefully remove the covering from between them using a modeling knife.

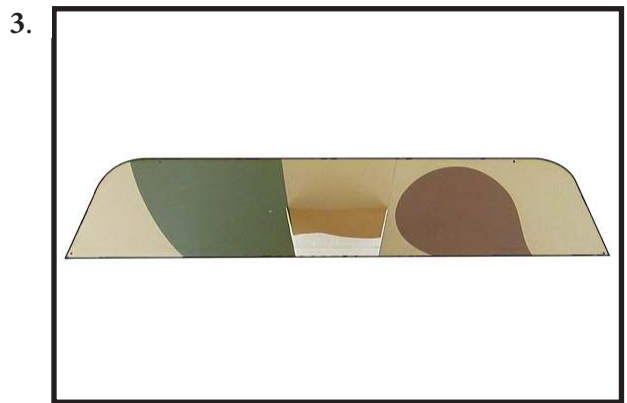

! *When cutting through the covering to remove it, cut with only enough pressure to only cut through the covering itself. Cutting into the balsa structure may weaken it.*

Using a modeling knife, carefully remove the covering that overlaps the stabilizer mounting platform sides in the fuselage. Remove the covering from both the top and the bottom of the platform sides.

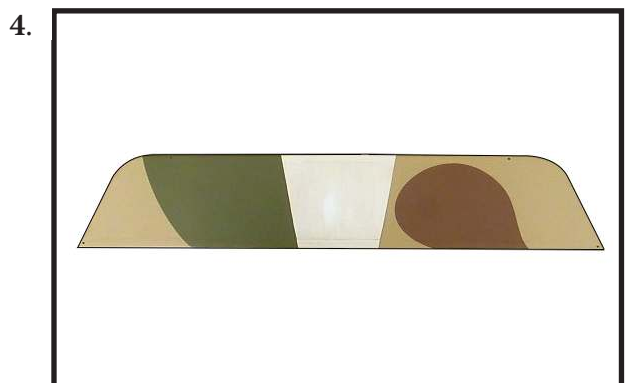

Slide the stabilizer partially into the fuselage so the wood at the center is exposed. Mix 1/2 ounce (15ml) of 30-minute epoxy. Use an epoxy brush to apply the epoxy to the exposed wood on the top of the stabilizer.

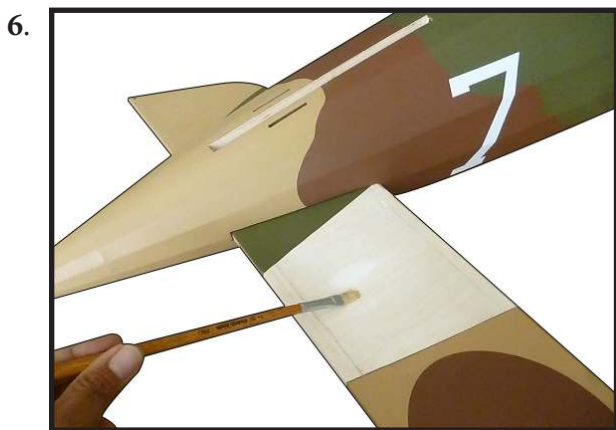
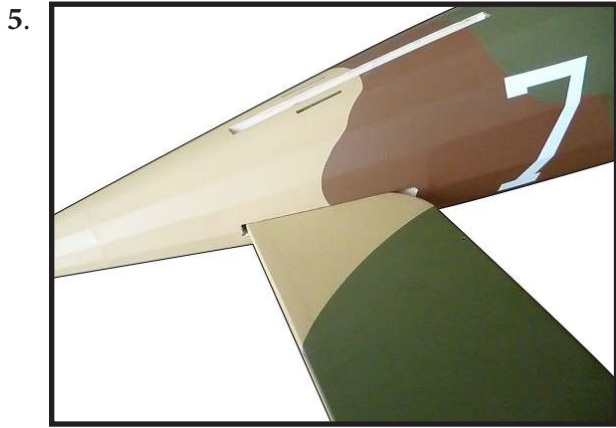

Carefully turn the model over and apply epoxy to the exposed wood on the bottom of the stabilizer. Slide the stabilizer back into position.

Use care not to get epoxy on the elevator joiner wire.

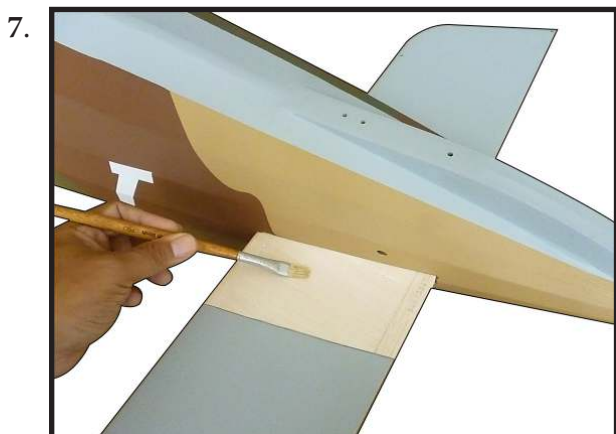

Once the alignment of the stabilizer has been verified, use a paper towel and isopropyl alcohol to remove any excess epoxy from the fuselage and stabilizer. Allow the epoxy to fully cure before proceeding.

If you find epoxy on the joiner wire, use the paper towel and isopropyl alcohol to clean the joiner.

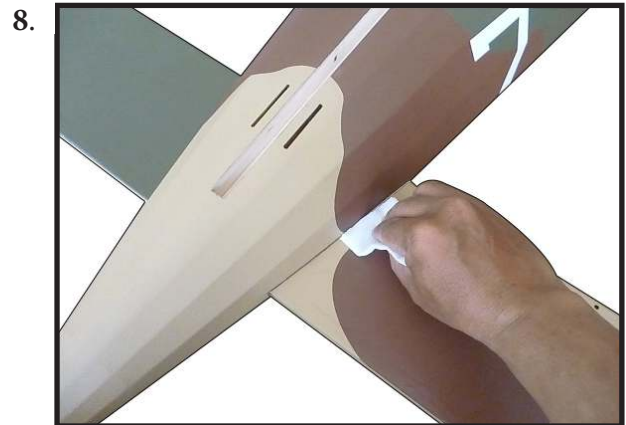

Use a pin vise and 1/16-inch (1.5mm) drill bit to drill a hole in the center of each hinge slot to allow the CA to wick into the hinge. Drill holes in both the elevators and stabilizer surfaces at this time. Place a T-pin in the center of each hinge along side the slot in the hinge. This will help center the hinge when it is placed in the elevators. Slide the hinges into position with the T-pin resting against the edge of the control surface.

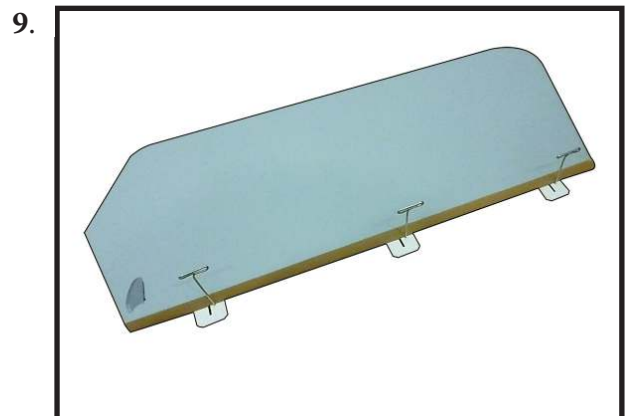

Fit the elevator into position on the stabilizer. Guide the joiner wire and hinges into position.

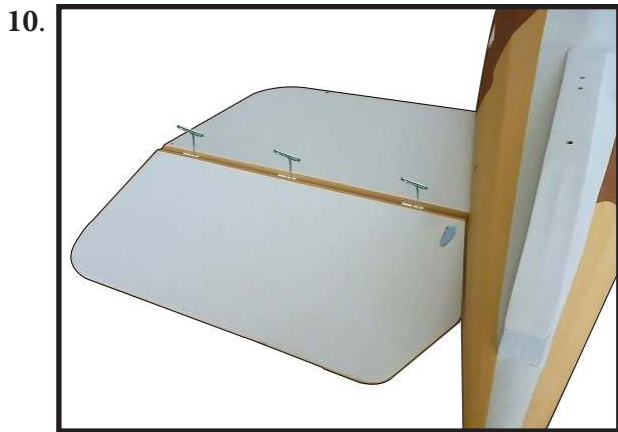

Fit the elevator so the leading edge fits tightly against the trailing edge of the stabilizer.



Check the fit of both elevators at this time. Once checked, remove the elevators.

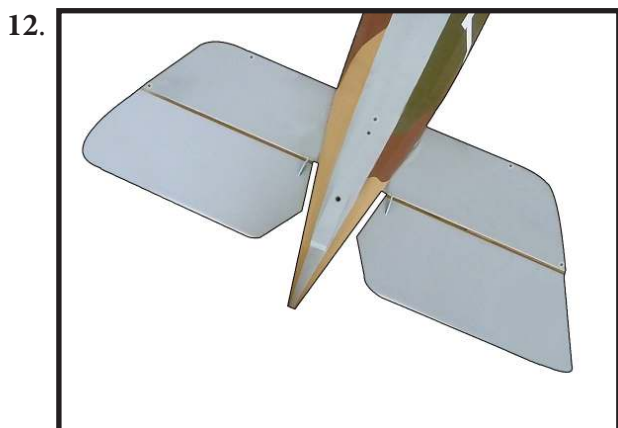

Fit the elevators back into position. Remove the T-pins and slide the elevators tightly against the stabilizer. Use a paper towel and isopropyl alcohol to remove any excess epoxy before it begins to cure.

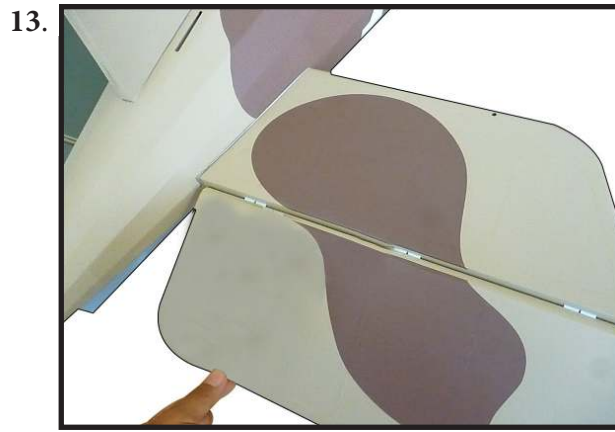

Flex the elevator slightly, making sure to keep the gap between the elevator and stabilizer as narrow as possible. Saturate each of the hinges using thin CA. Apply CA to the top of the hinges.

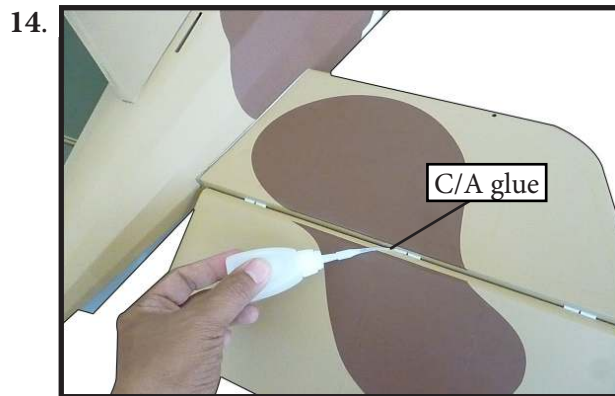

Gently pull on the fixed and moving surface to make sure the hinges are glued securely. If not, reapply thin CA to any hinges that are found loose.

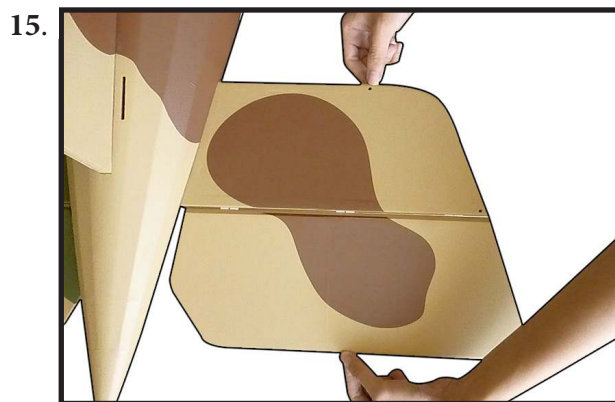

Flex the control surface through its range of motion a few 28. times to break-in the hinges. This will reduce the initial load on the servo when the surface is first actuated.

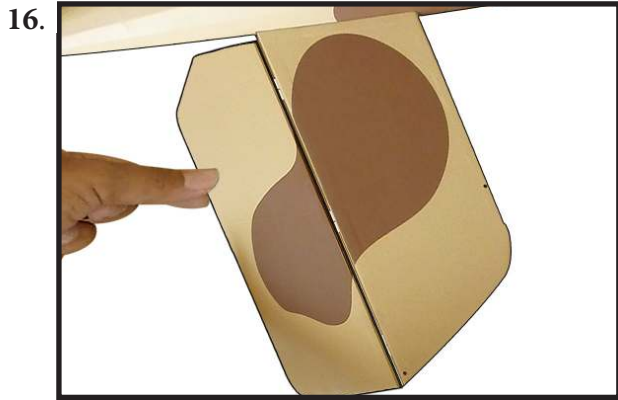

INSTALL RUDDER CONTROL HORN

Repeat steps to install the rudder control horn as same as steps done for ailerons.

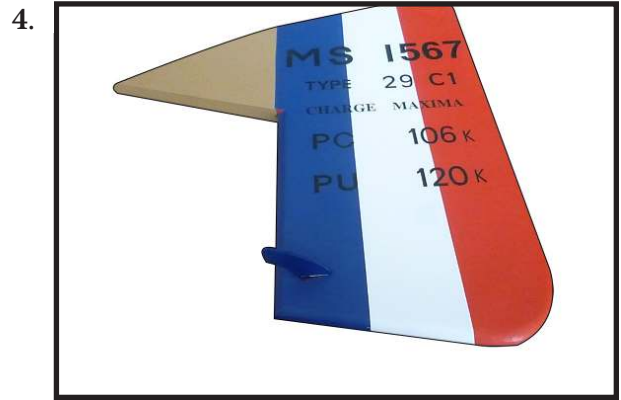
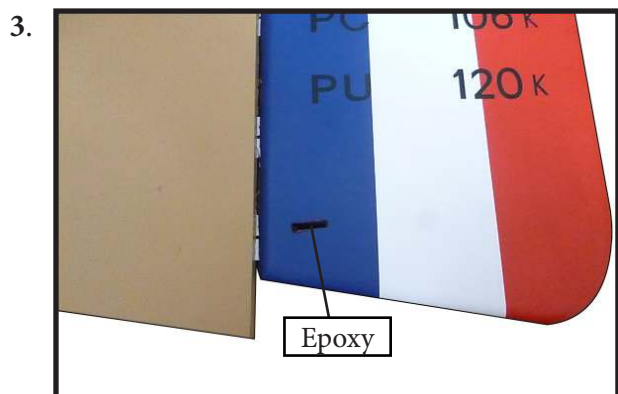
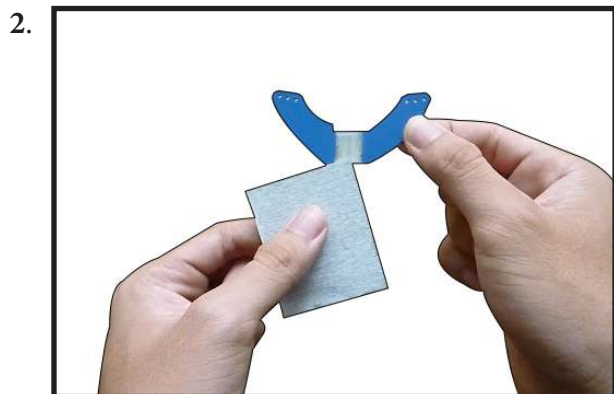
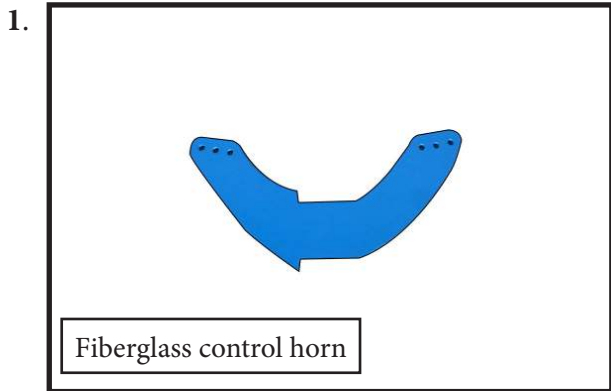

INSTALLING VERTICAL STABILIZER

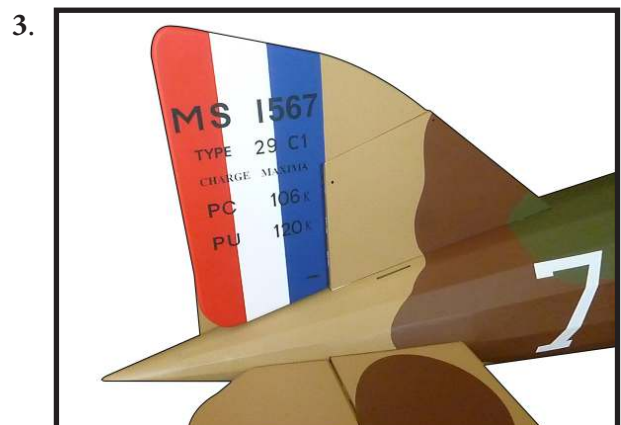
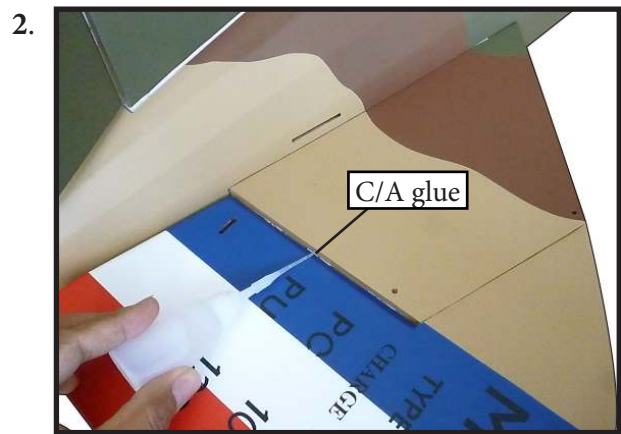
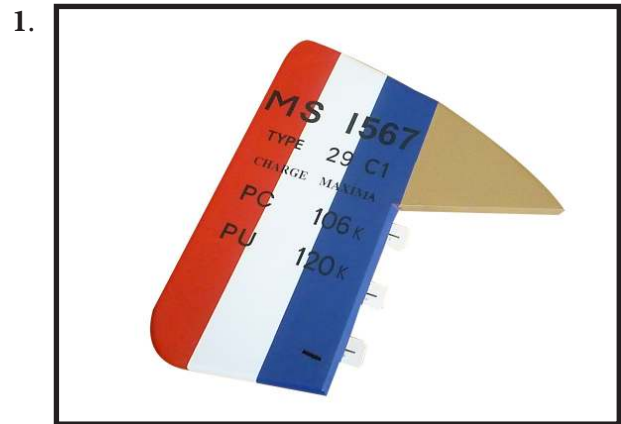

ELEVATOR PUSHROD INSTALLATION

Install the elevator control horn using the same method as with the aileron control horns.

Position the elevator control horn on the both side of elevator.

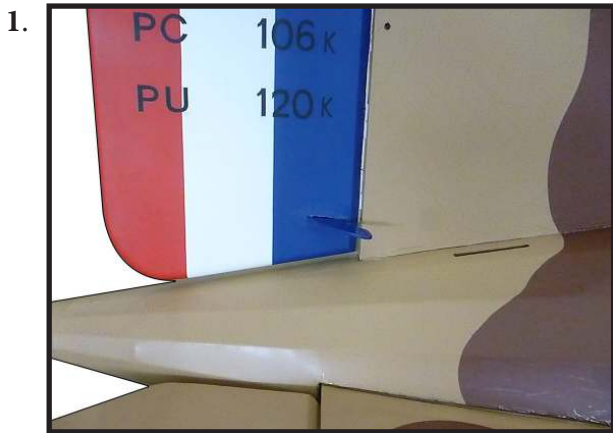

Thread one clevis and M2 lock nut on to each elevator control rod. Thread the horns on until they are flush with the ends of the control rods.

Elevator and rudder pushrods assembly as pictures below.

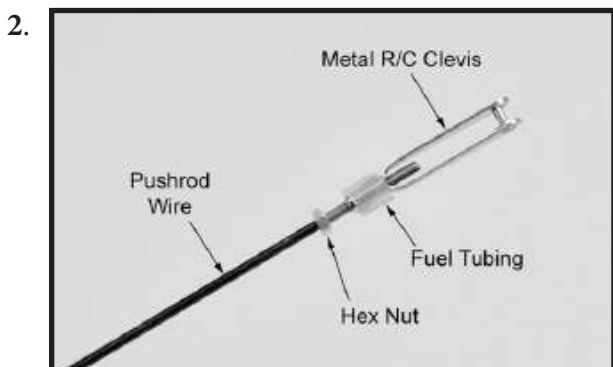

Locate items necessary to install rudder pushrod.

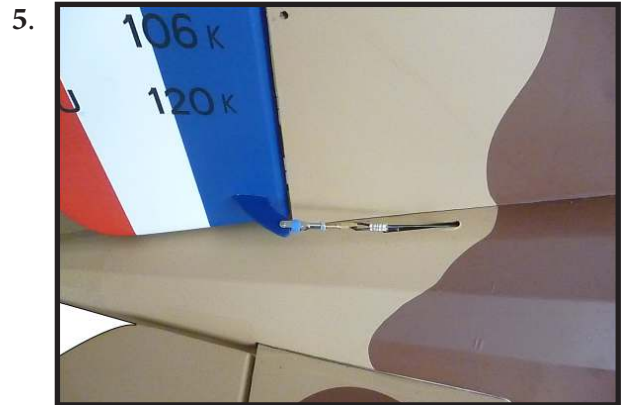
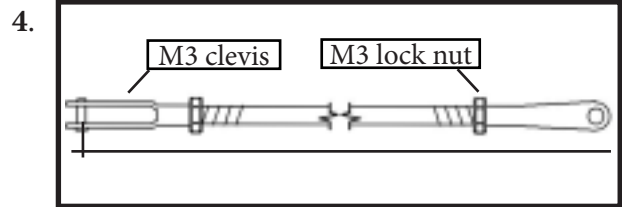
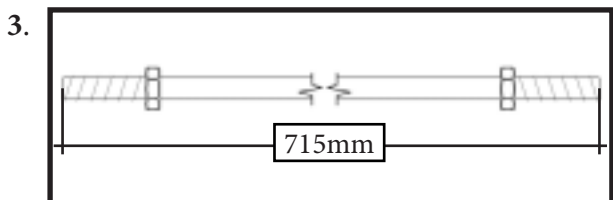

RUDDER PUSHROD INSTALLATION

Repeat steps as same as steps done for elevator.



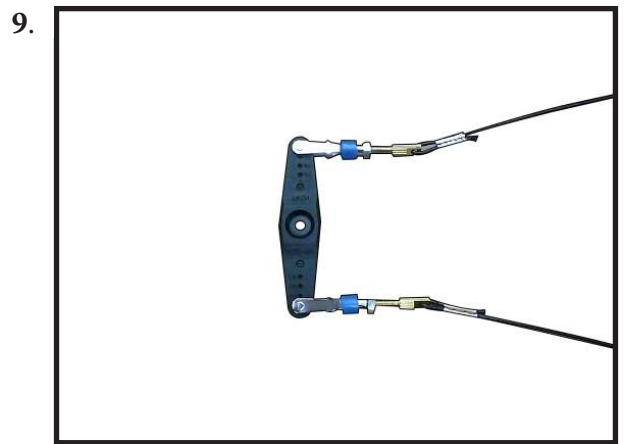
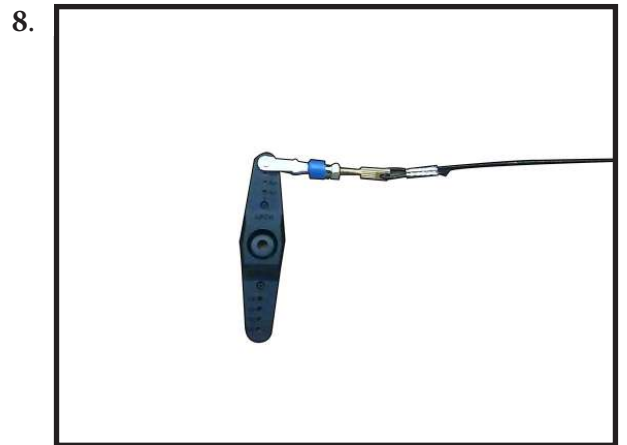
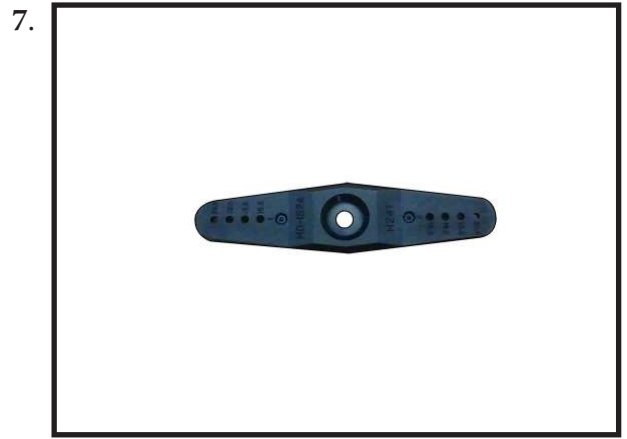
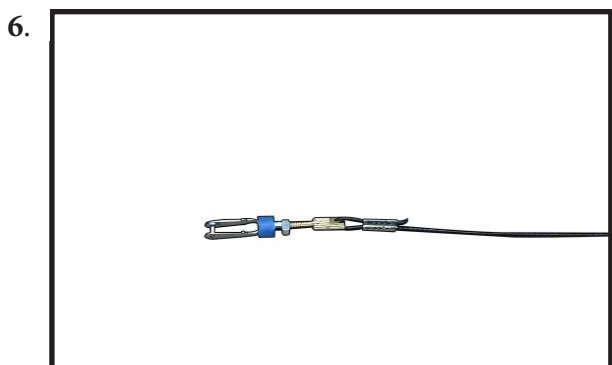
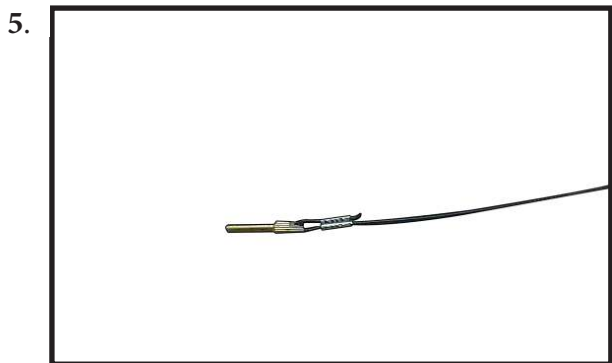
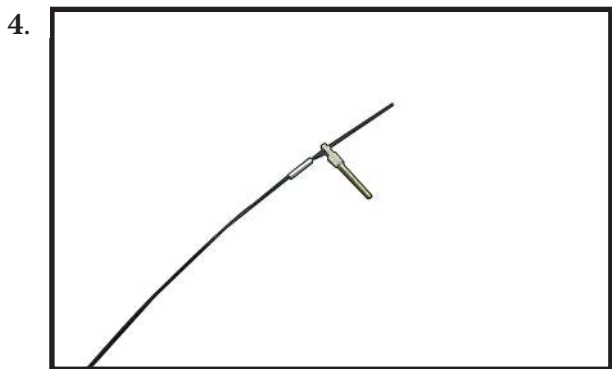
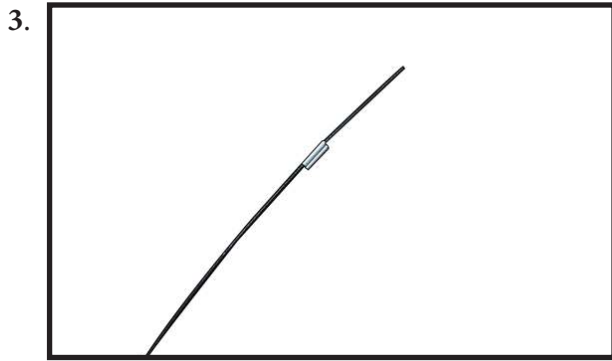
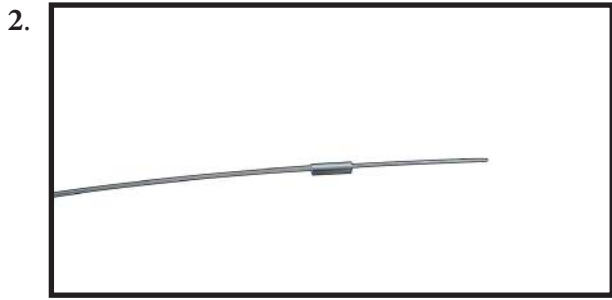

11.

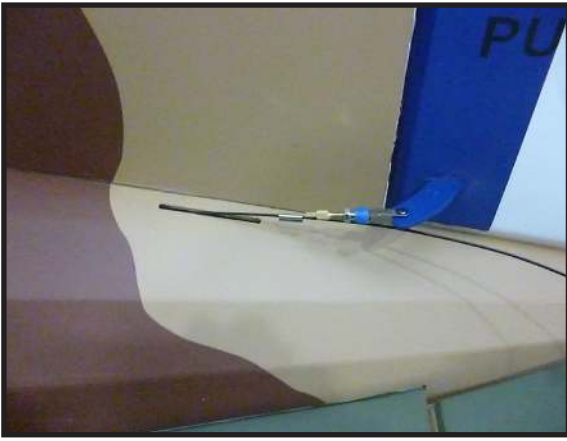

12.

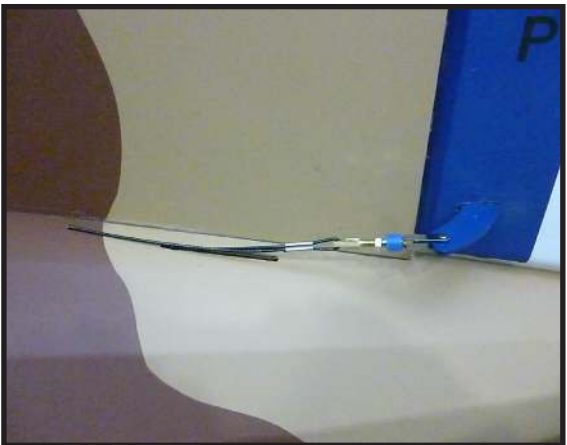

13.

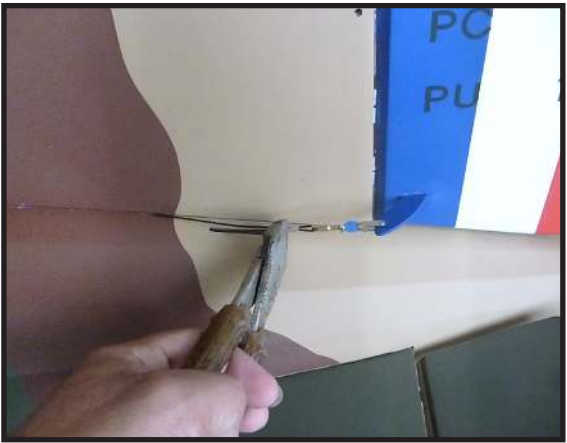

14.



MOUNTING THE TAIL WHEEL

Locate items necessary to install tail wheel.

1.

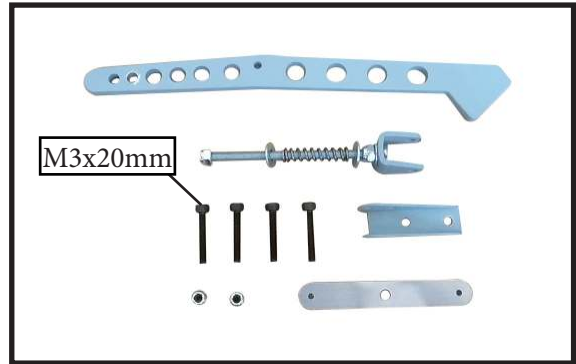

2.

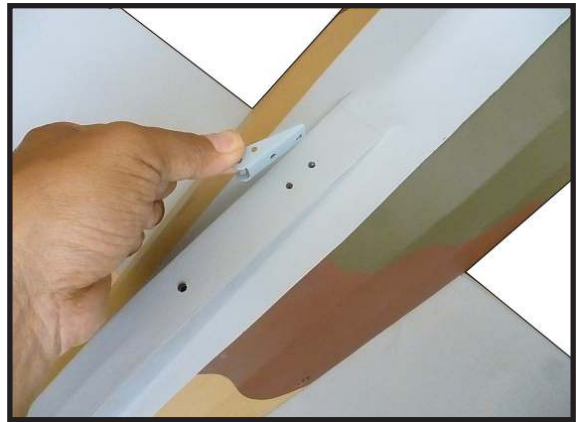

3.



4.

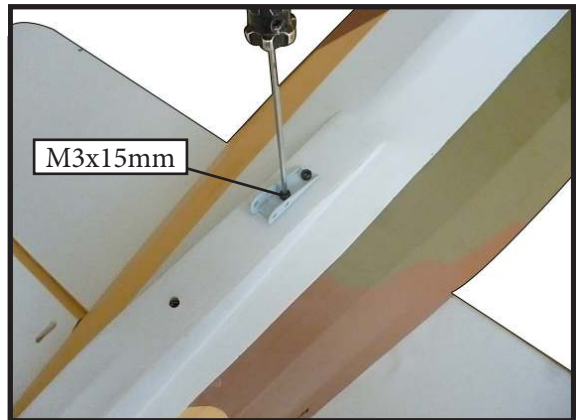

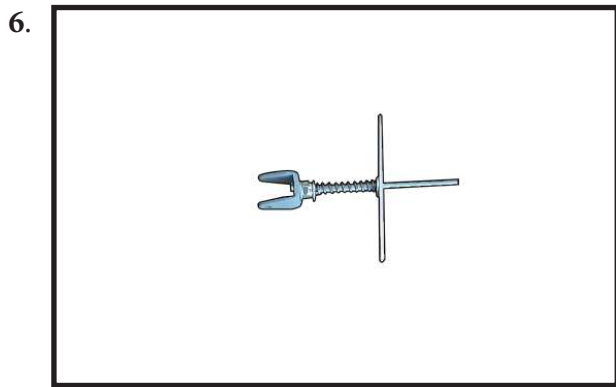
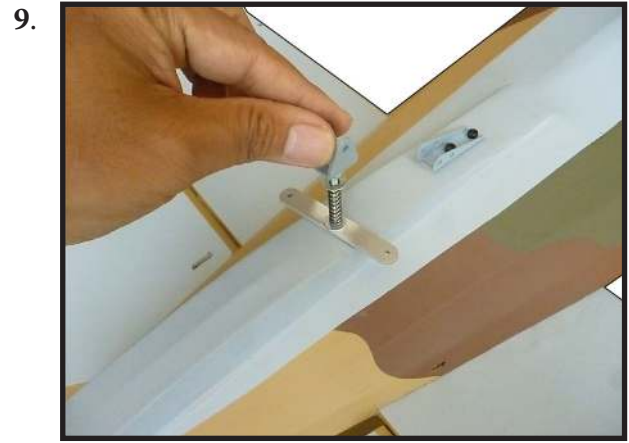
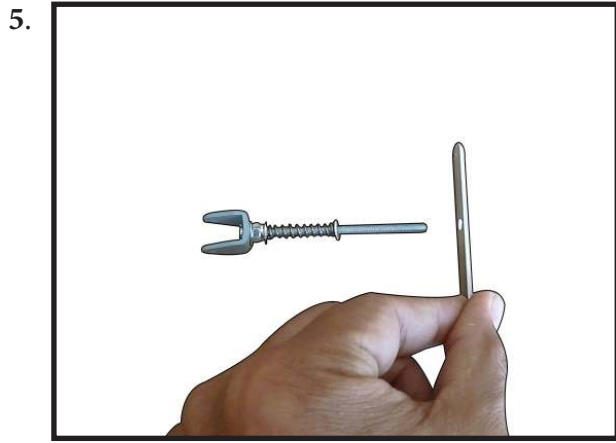

Make sure you have loctite glue or it will come loose.

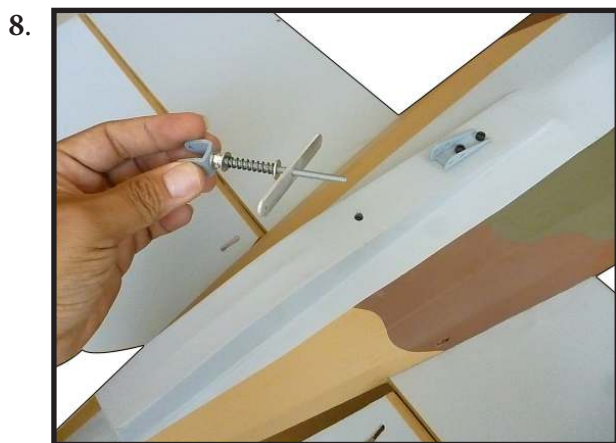
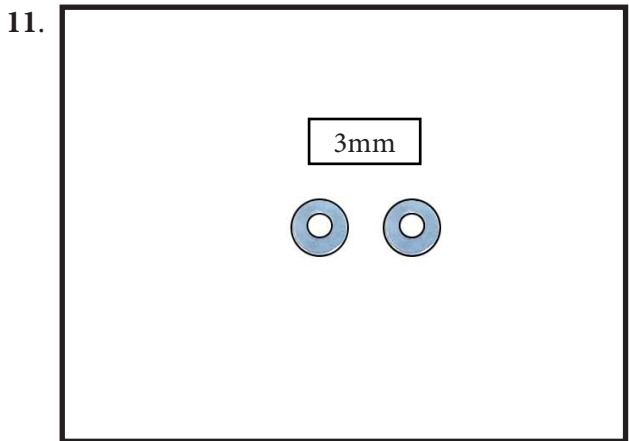
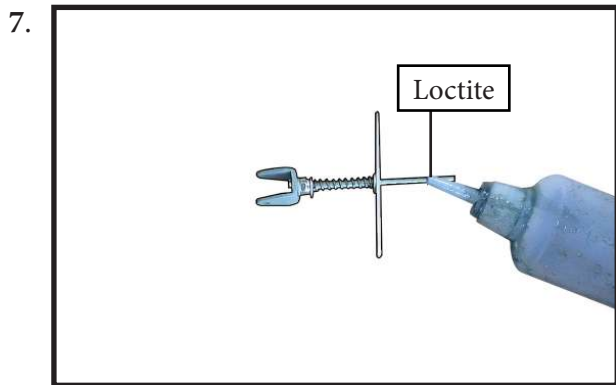

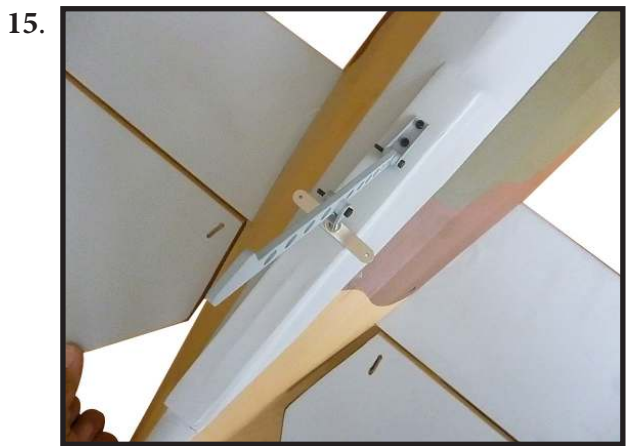
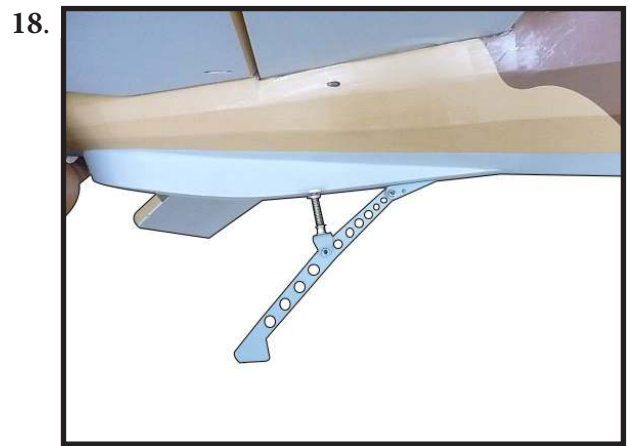
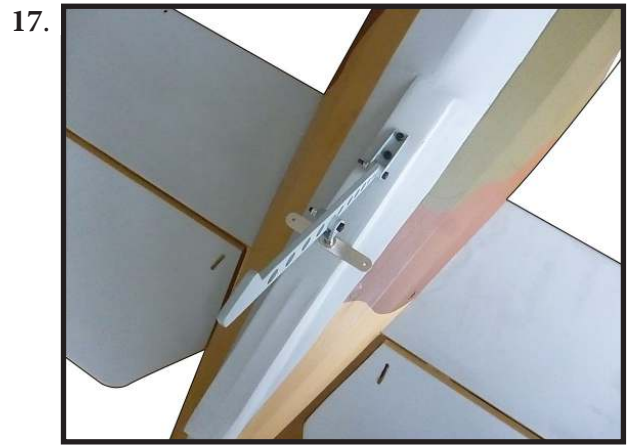
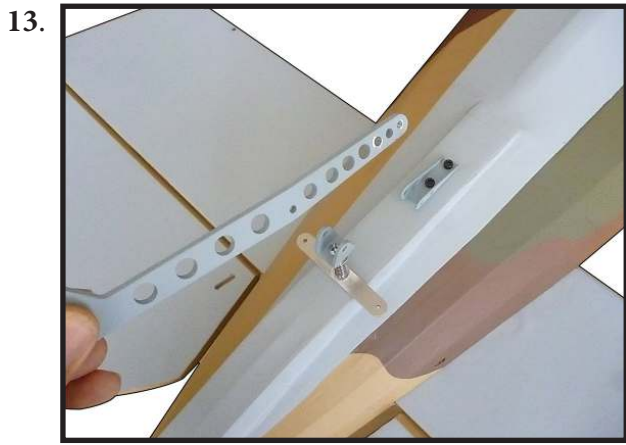

INSTALL BRACING WIRE AND METAL BRACKET AT THE TAIL

TOP VIEW.

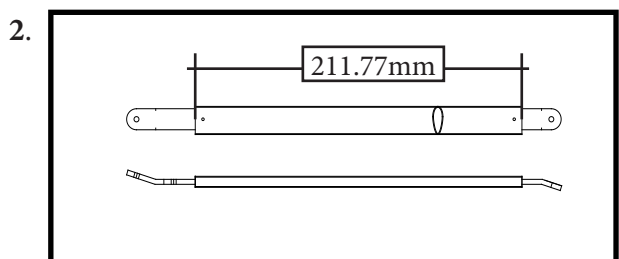

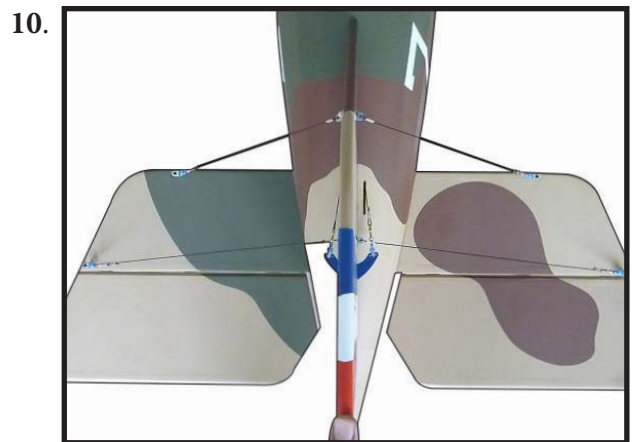
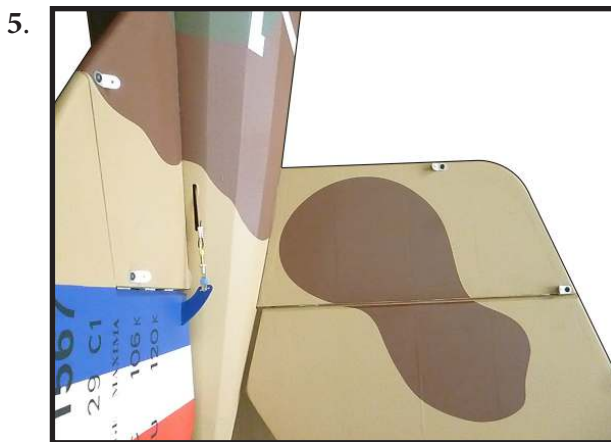
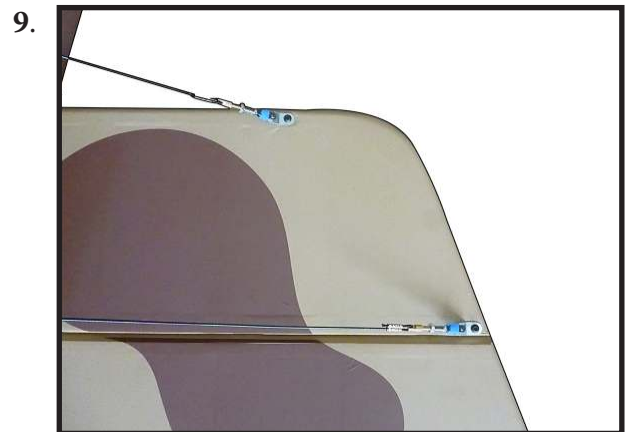
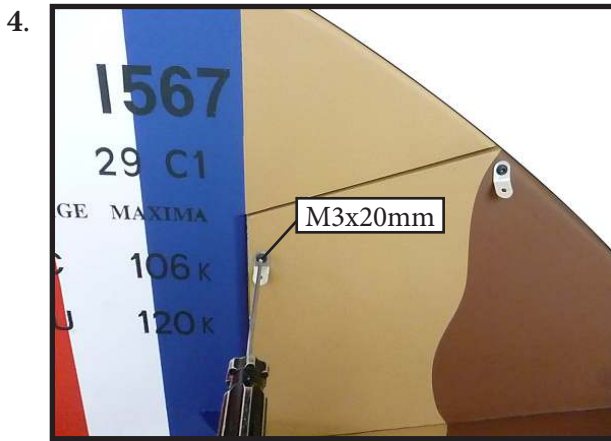
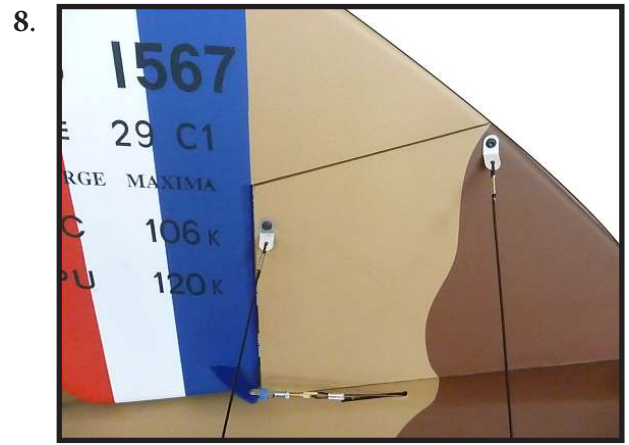
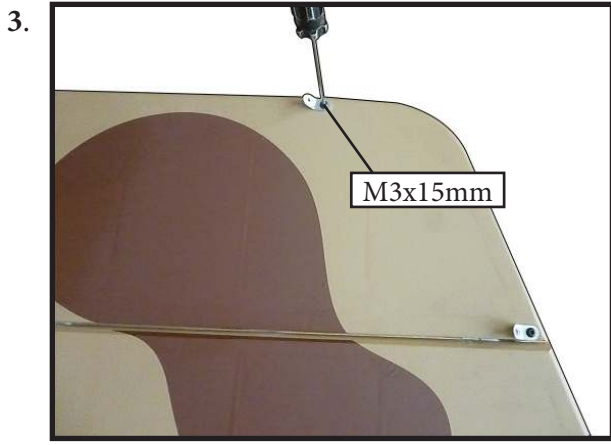

BOTTOM VIEW.

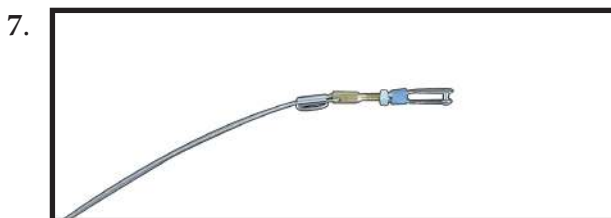

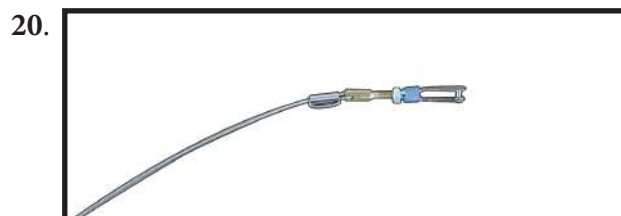
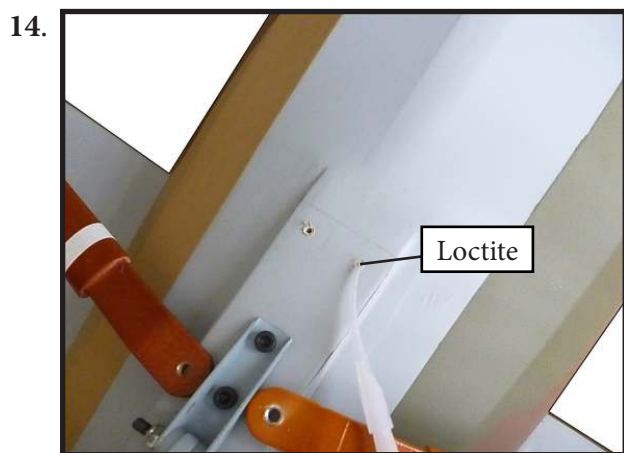

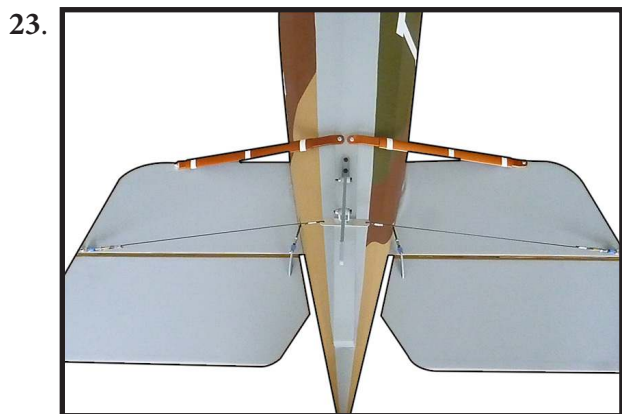
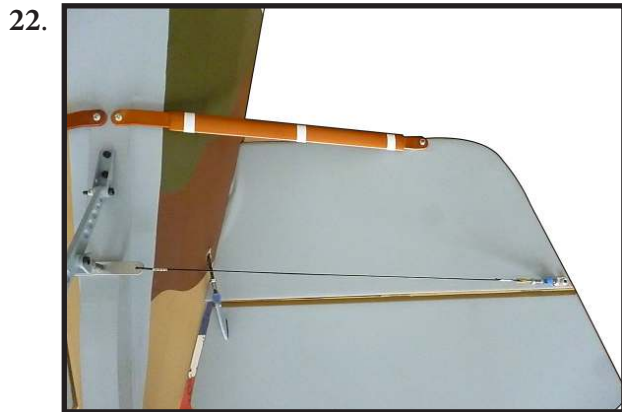
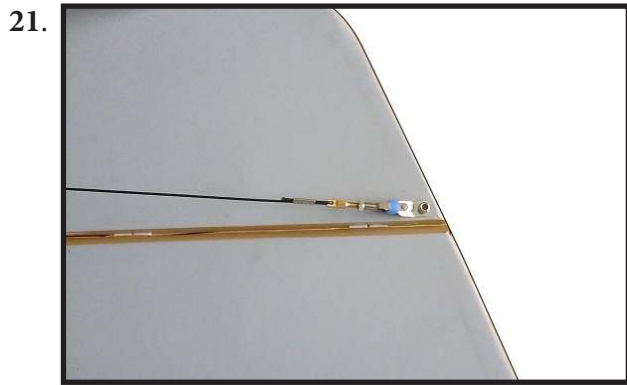

INSTALL GUN

Parts requirement. Please study images below.

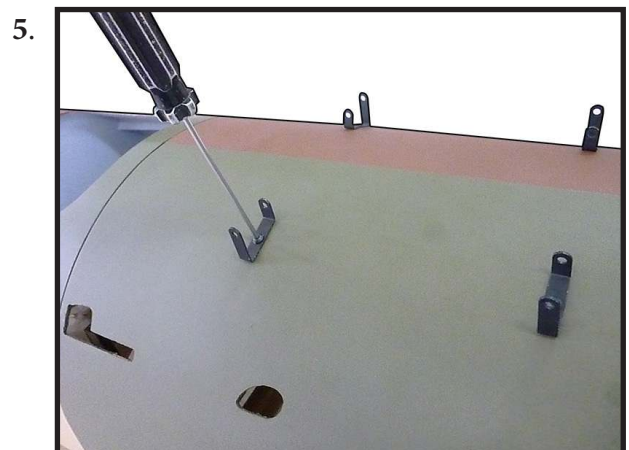
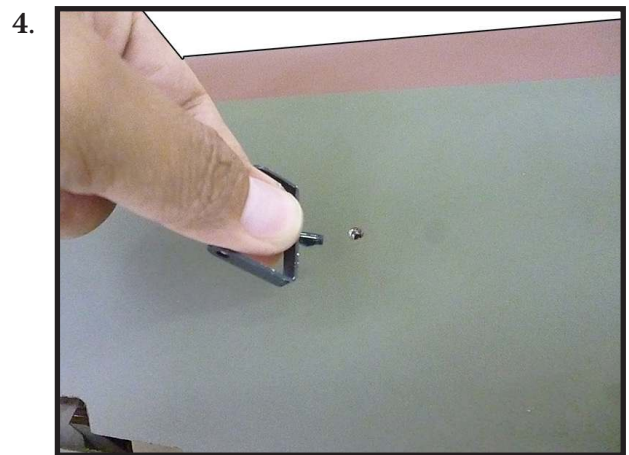
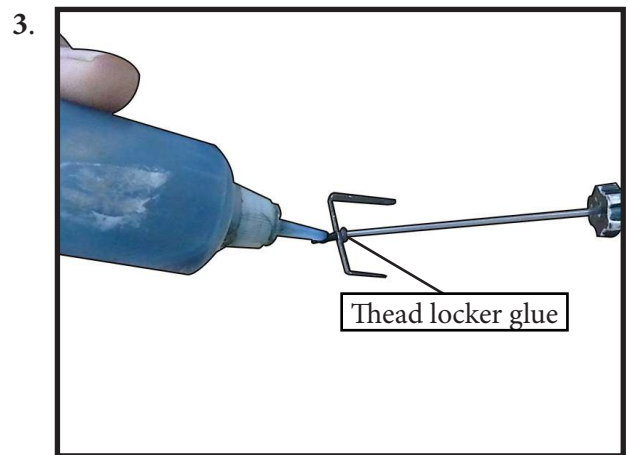
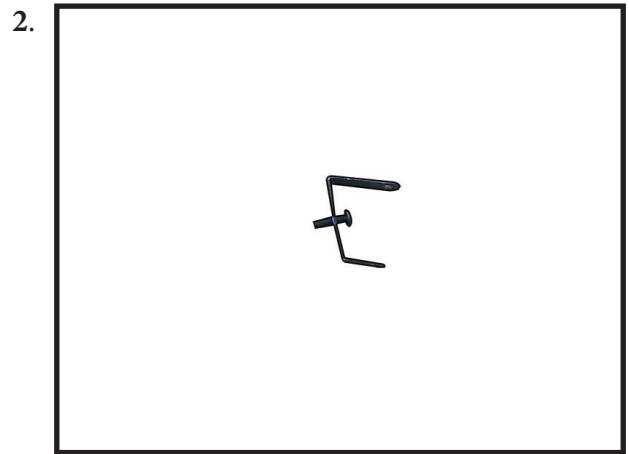

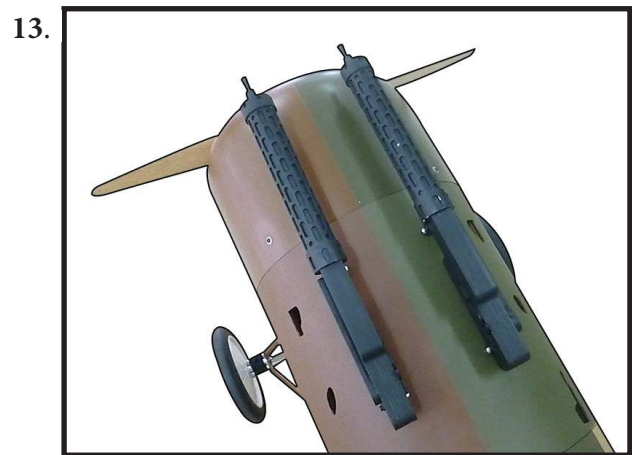
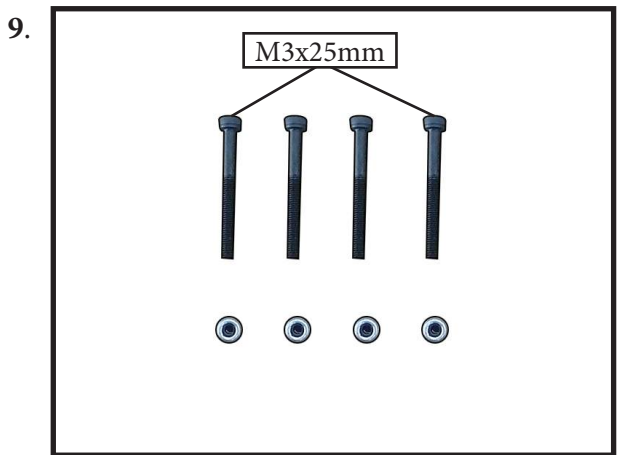
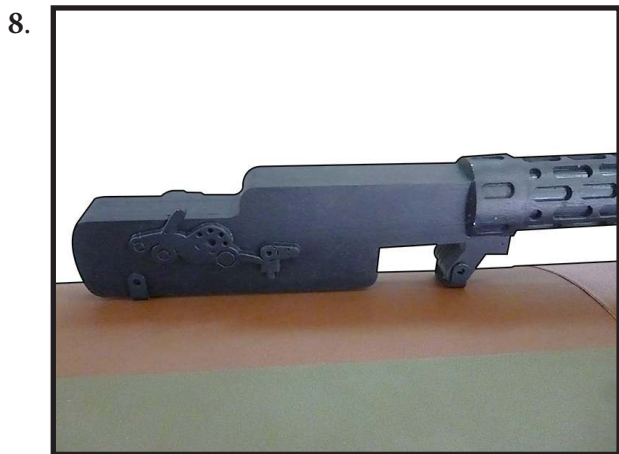
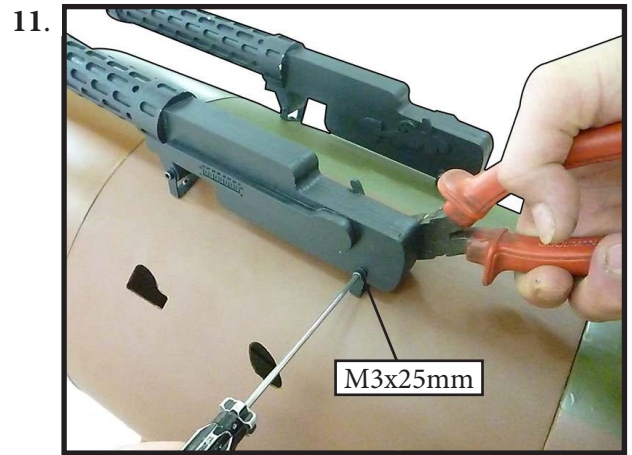
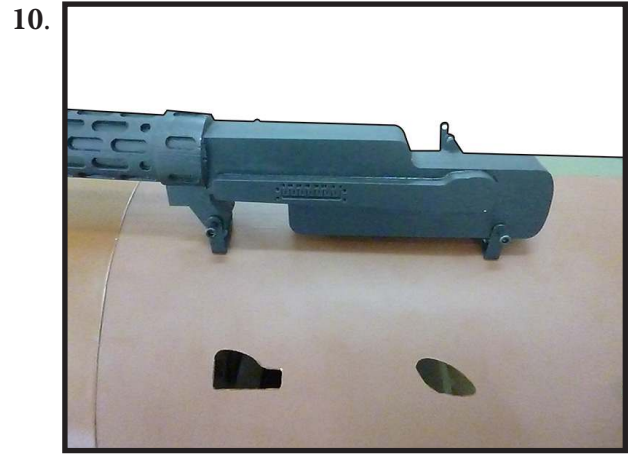
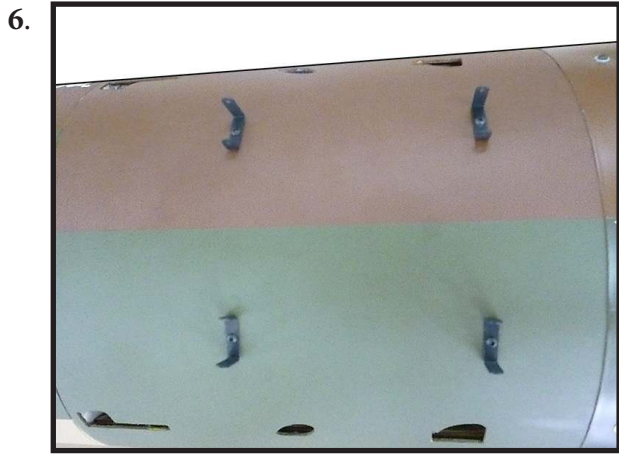

CABANE STRUT INSTALLATION

Loacte the items for this section of the manual.

1.

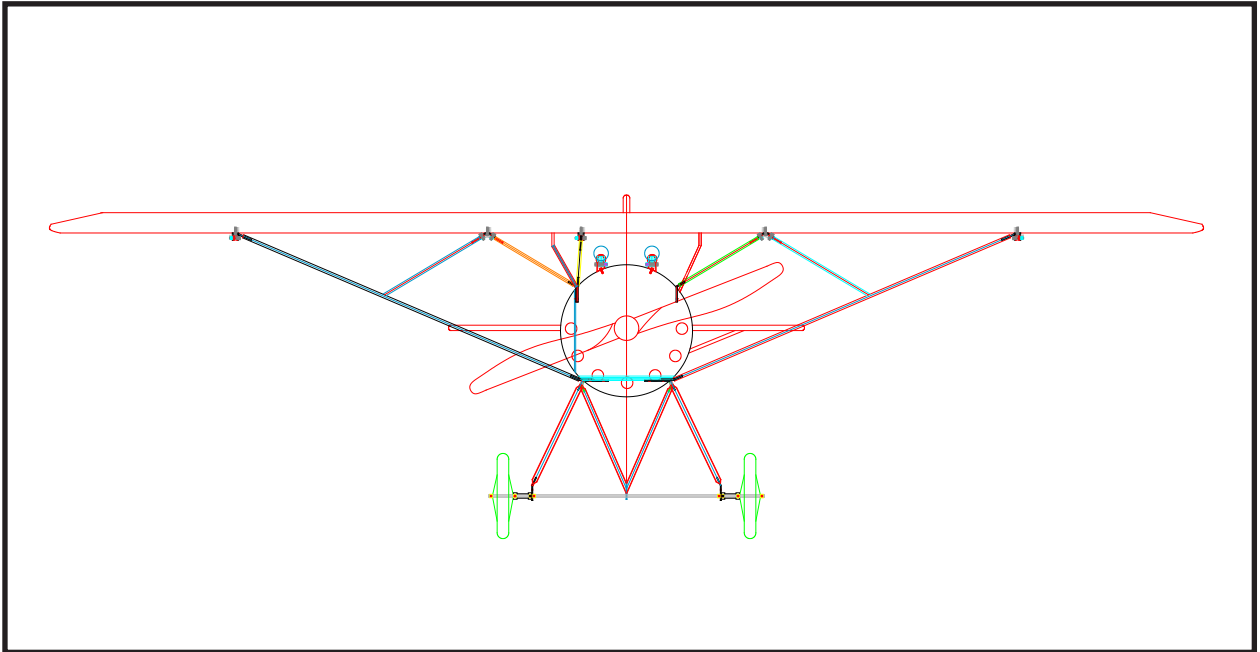

Decor for the strut.

2.

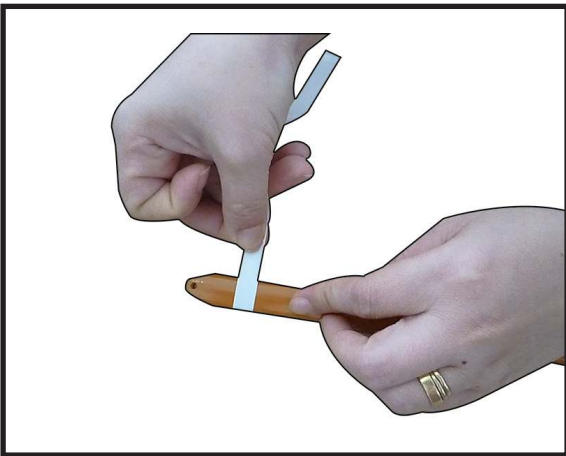

3.

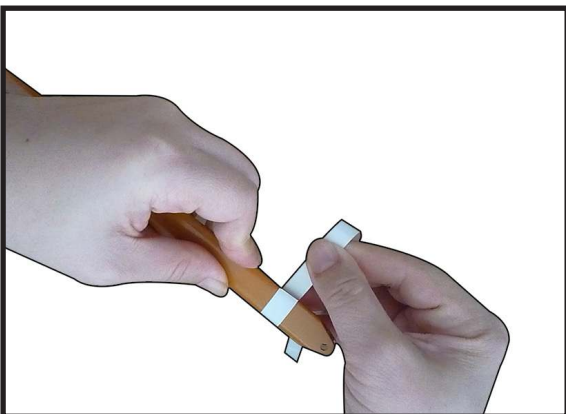

4.

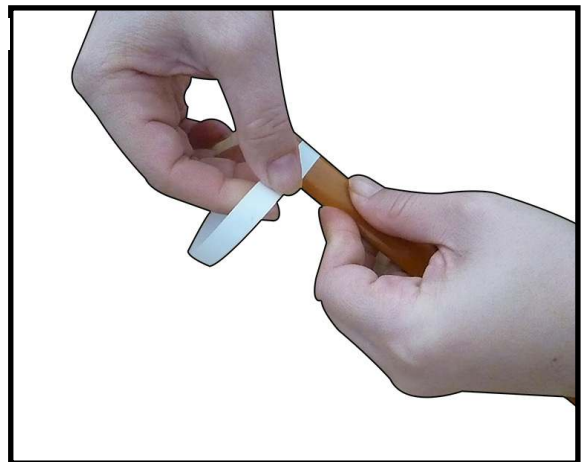

5.

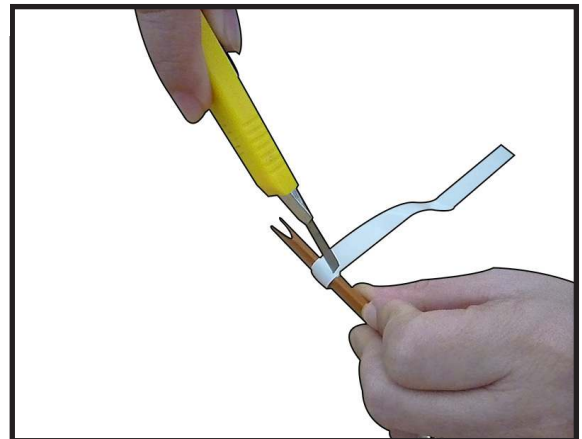

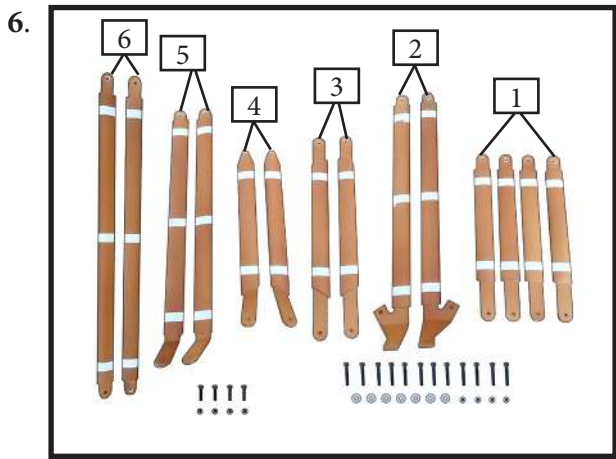

Get the middle number 1 strut and install it on the fuselage.

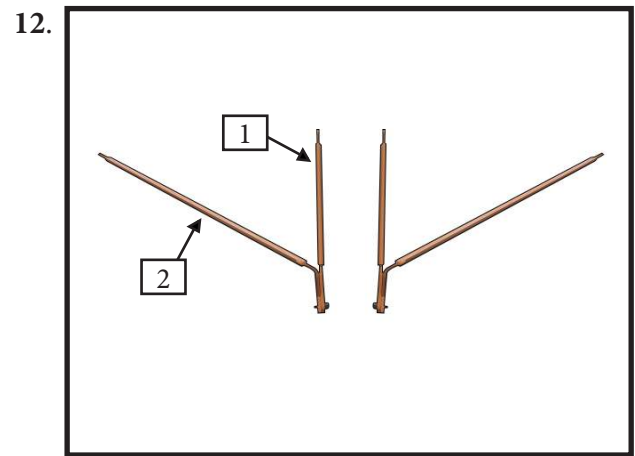
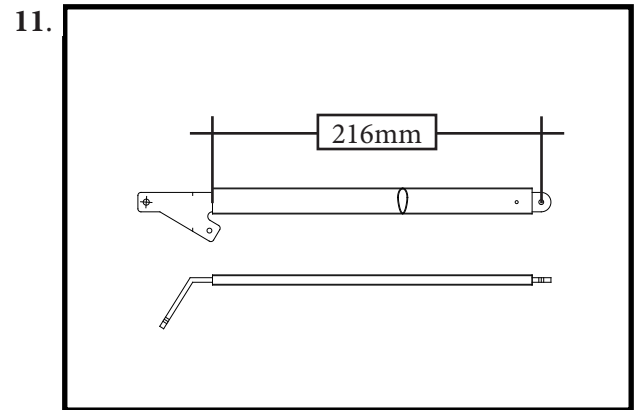
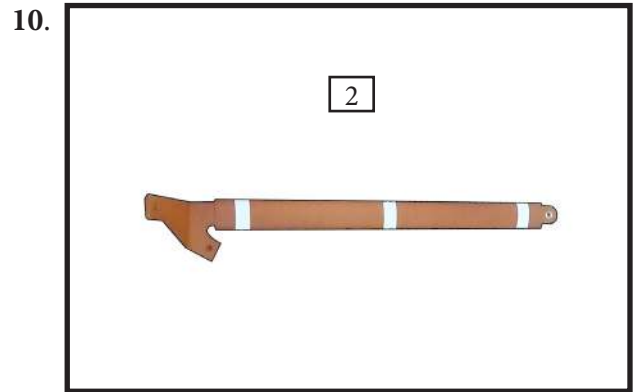
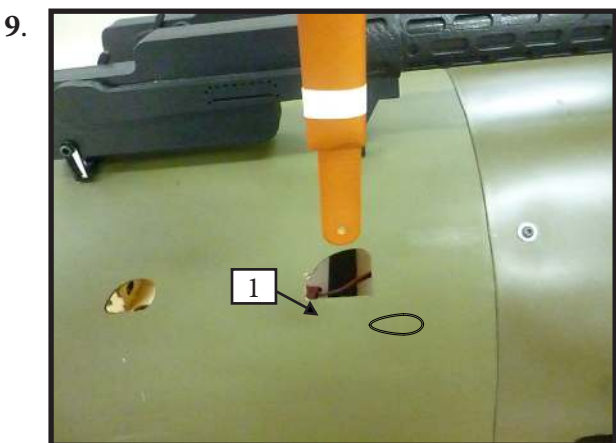
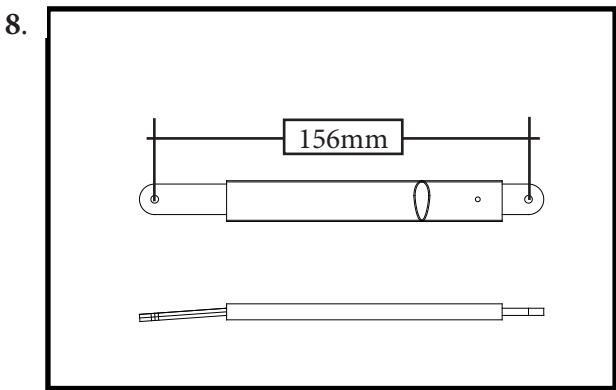
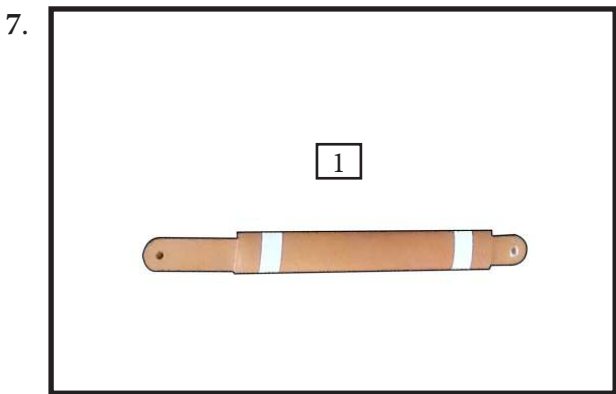

Setting the number 2 with the number 1.

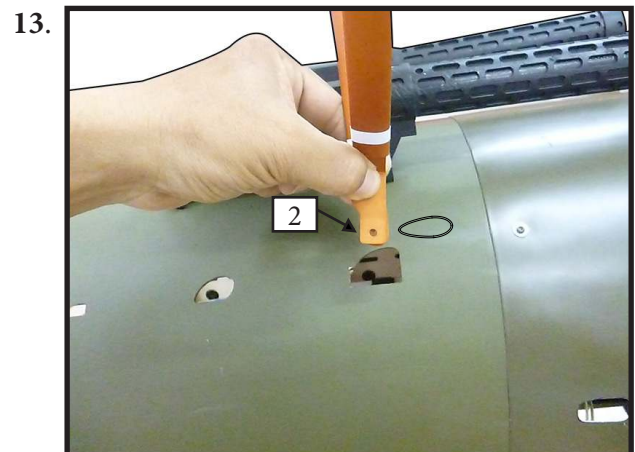



Get the middle number 3 strut and install it on the fuselage.

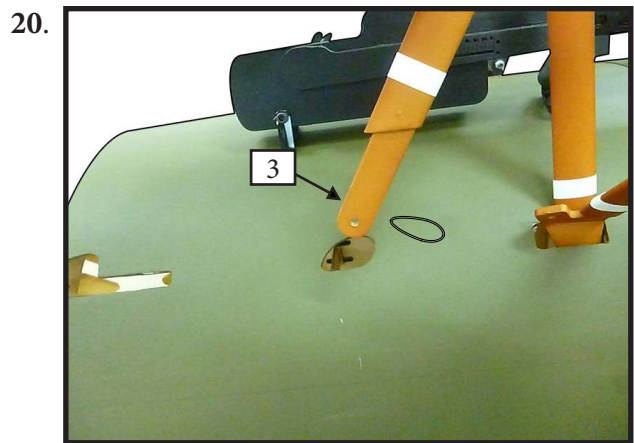
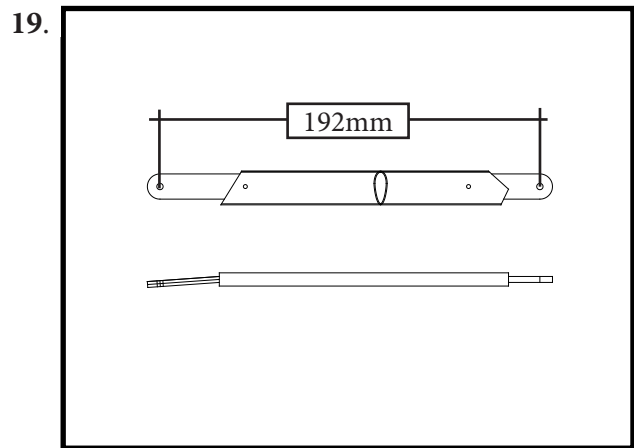
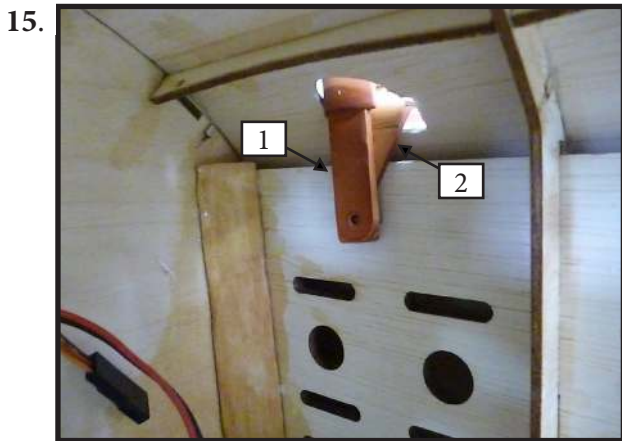
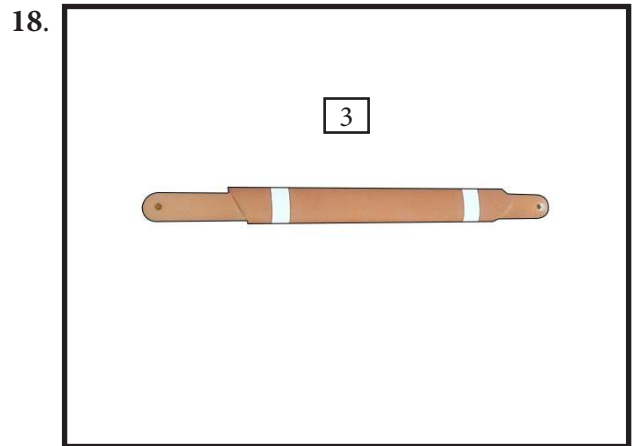

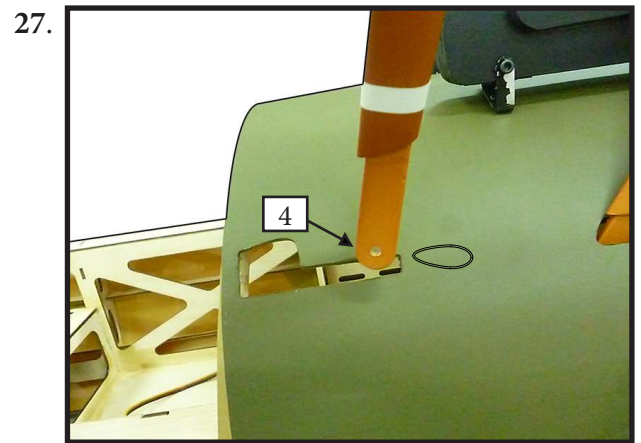
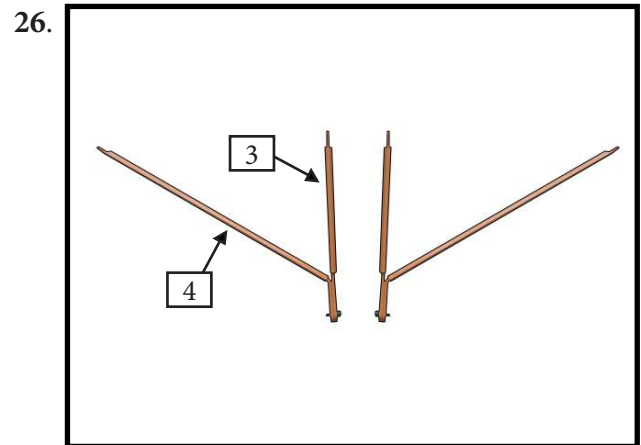
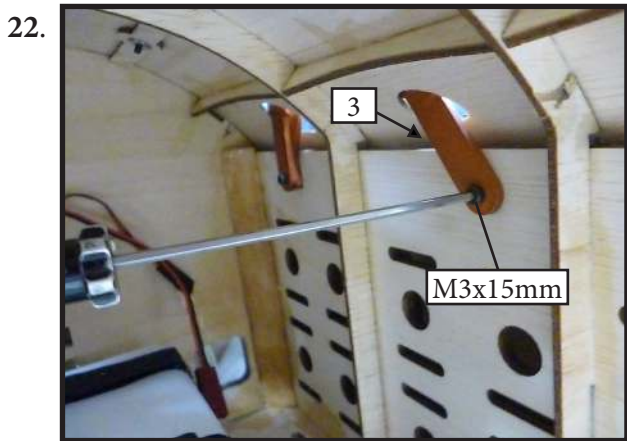
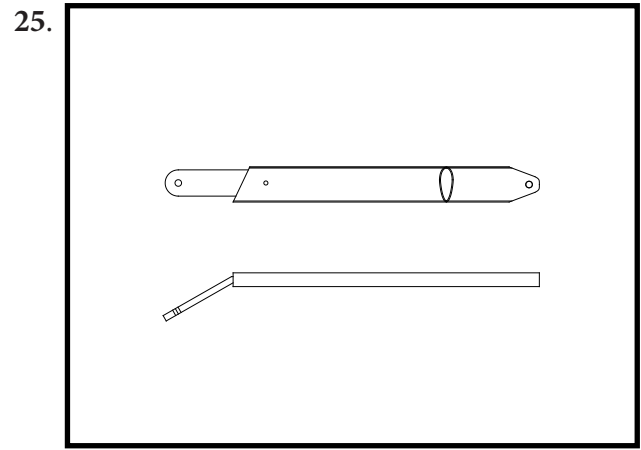

Get the middle number 4 strut and install it on the fuselage.

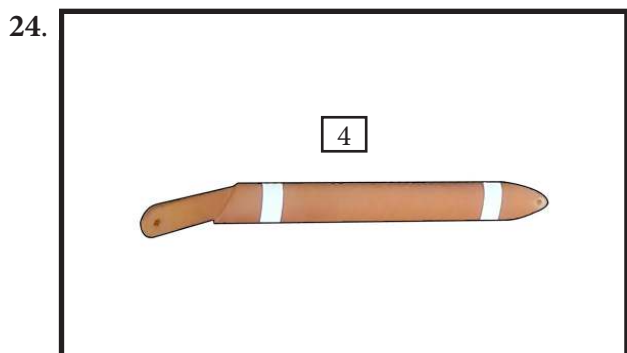

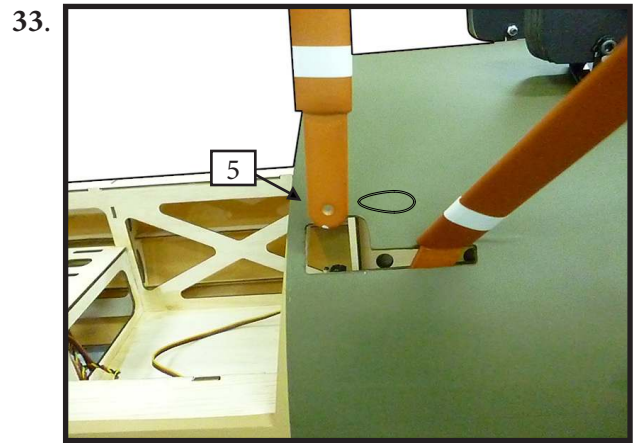
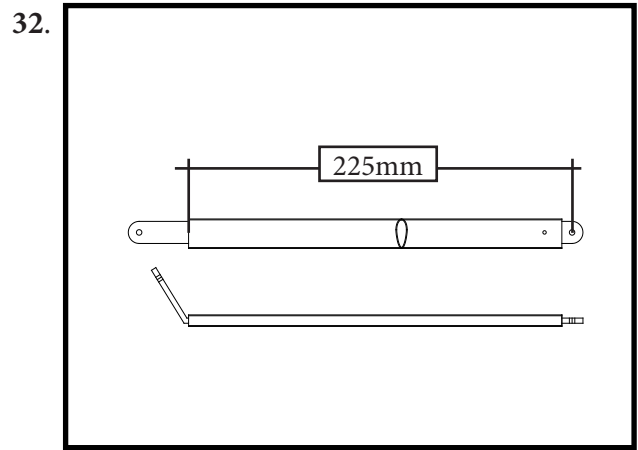
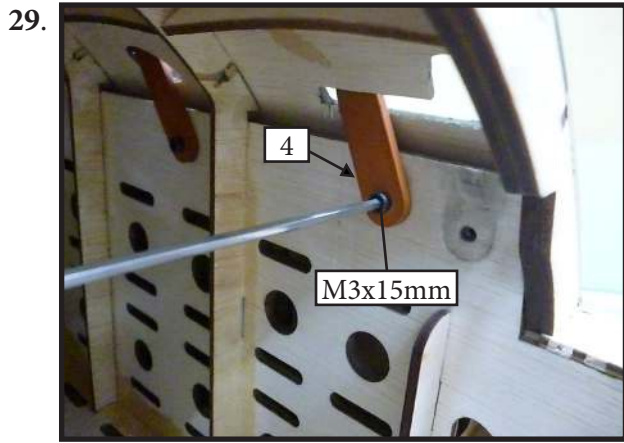

Setting the number 5 with the number 1.

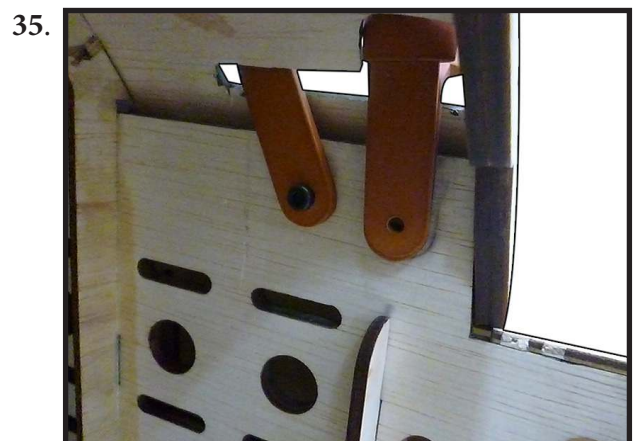
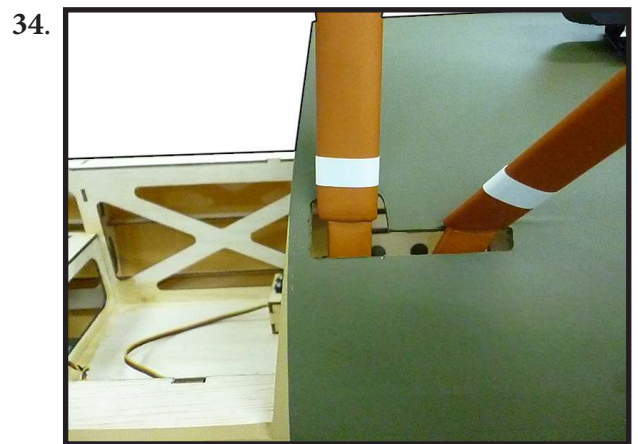
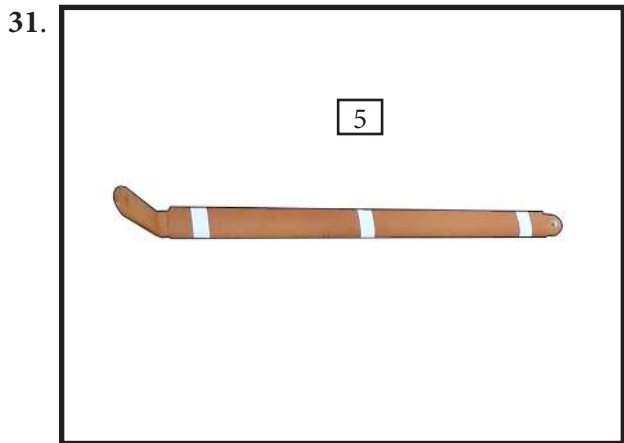

36.

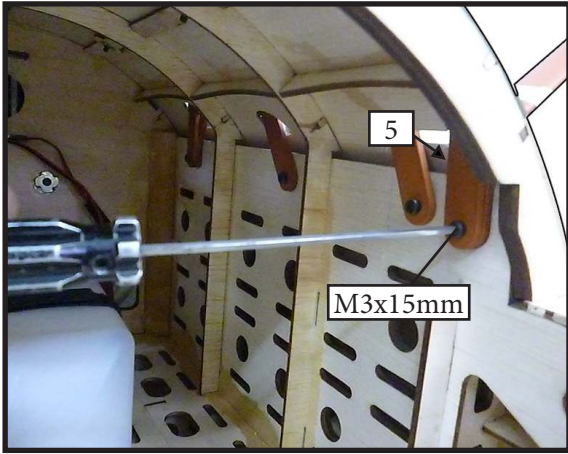

40.

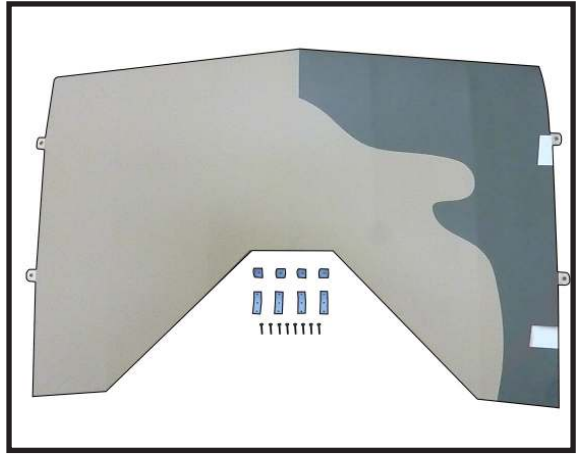

37.



41.

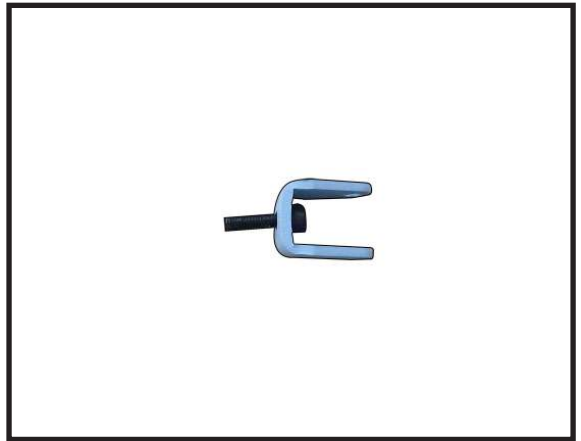

38.

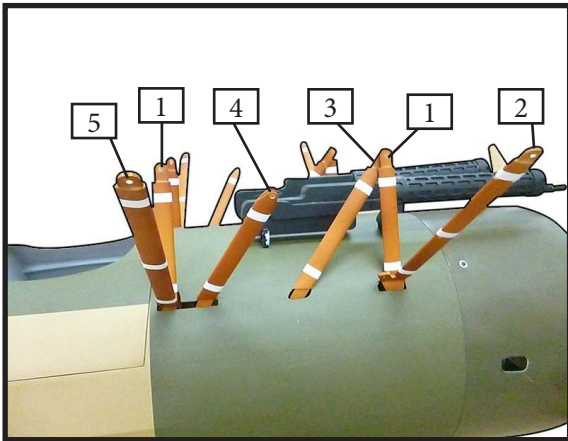

42.

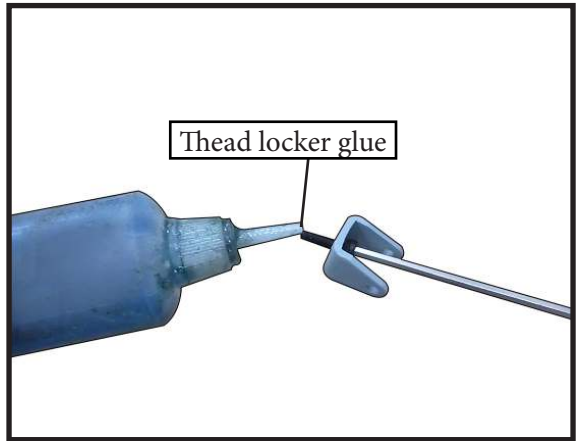

39.

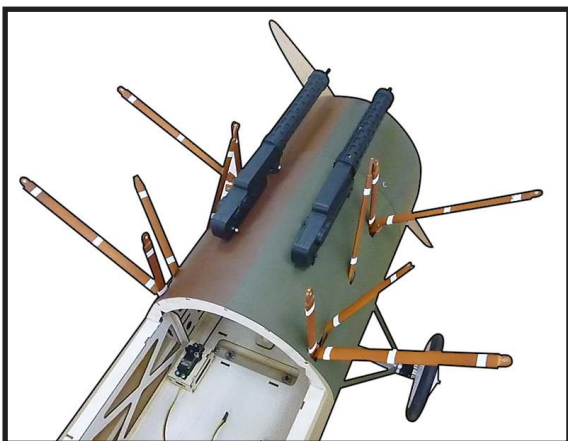

43.

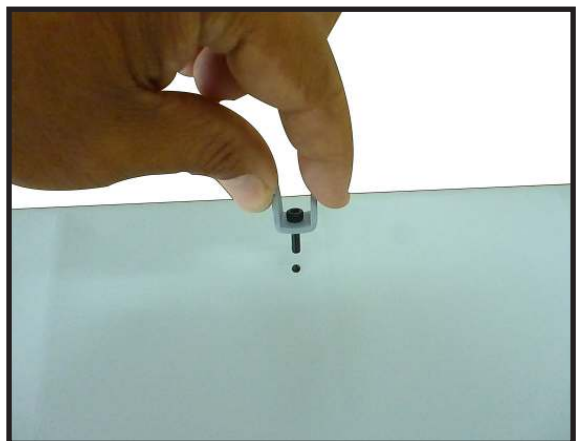

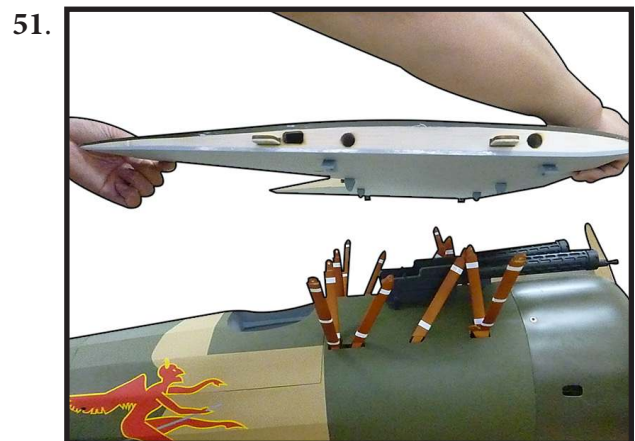
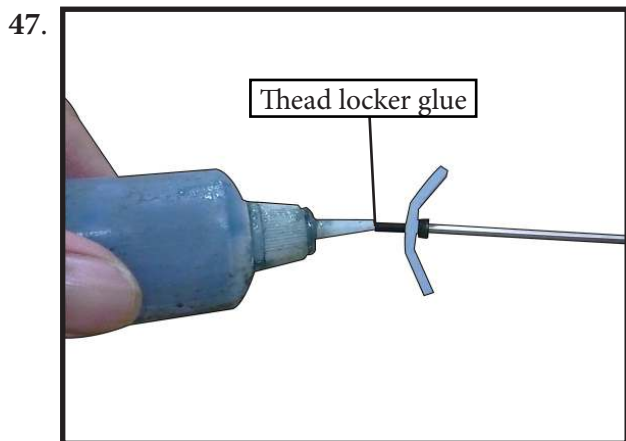
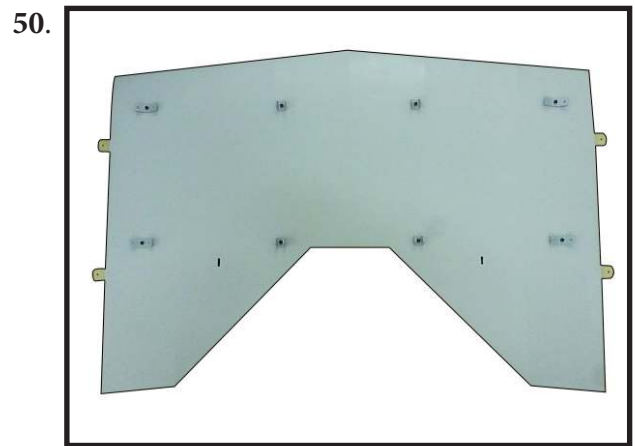
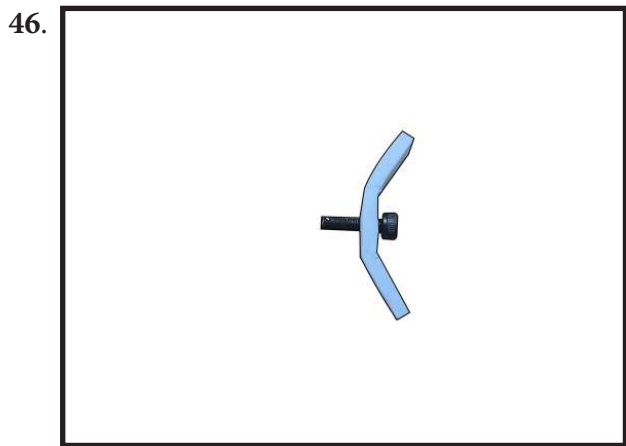
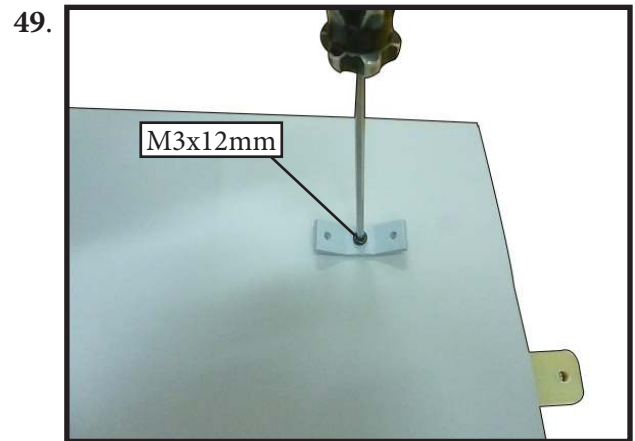
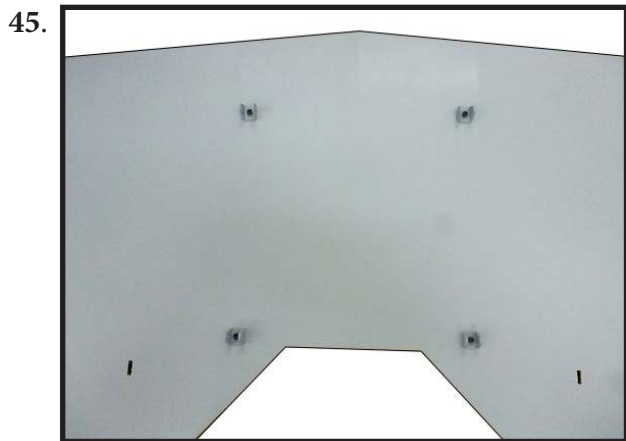
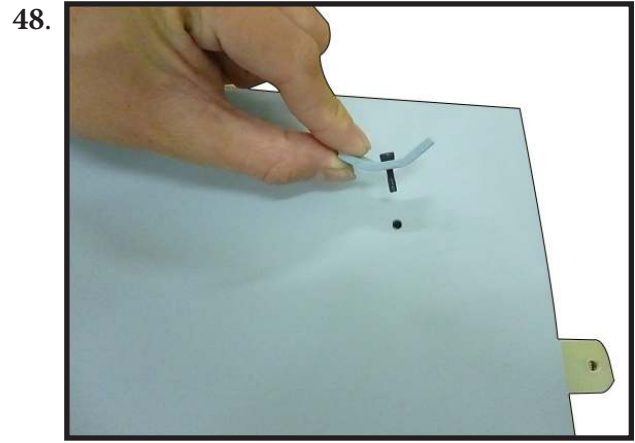
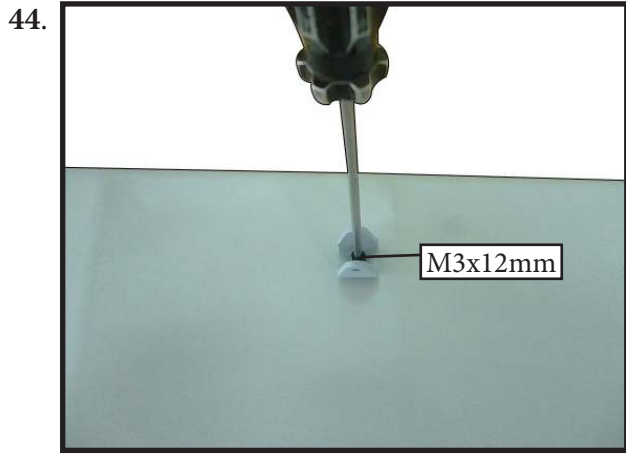

52.

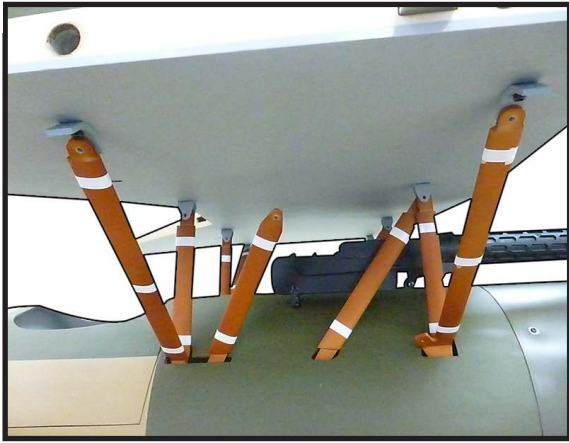

56.

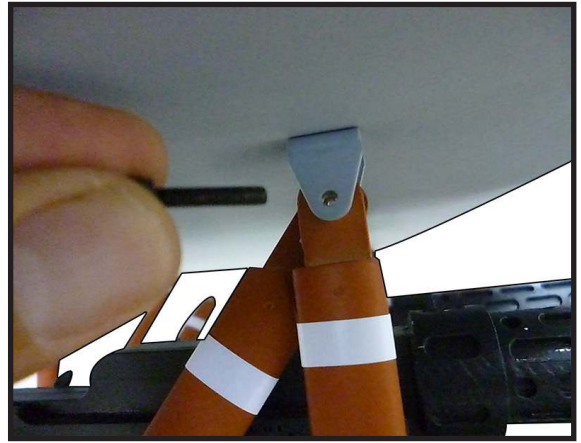

53.

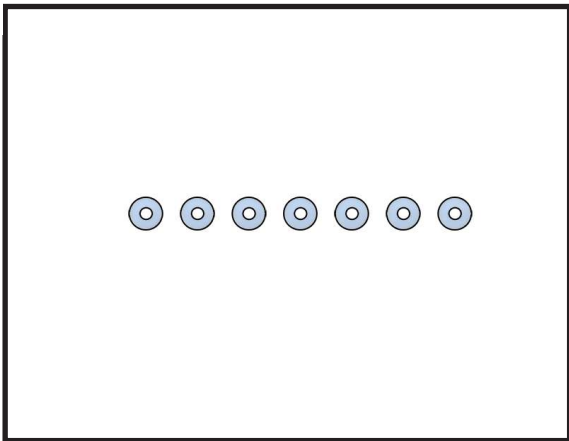

57.



54.

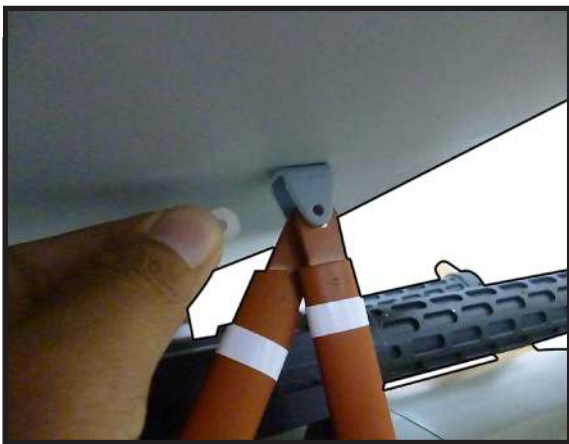

58.

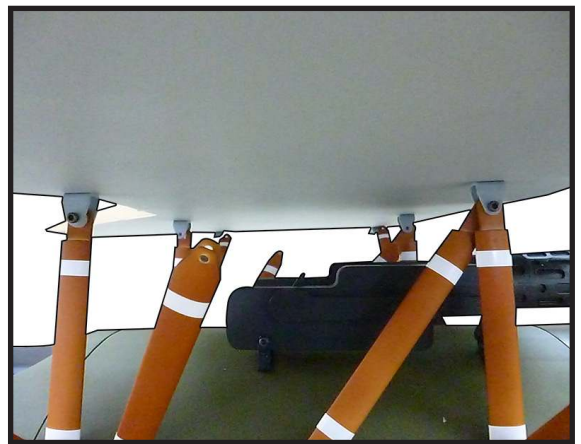

55.

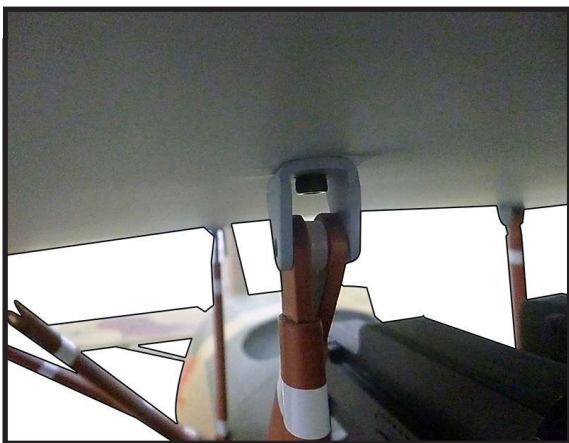

59.

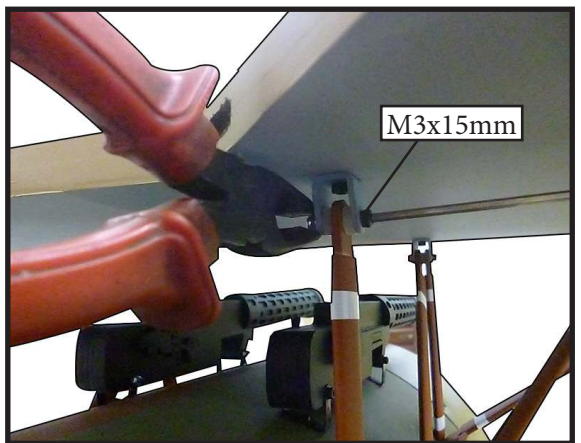

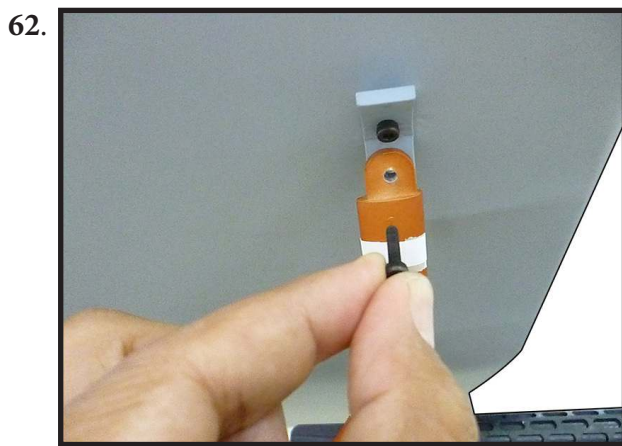
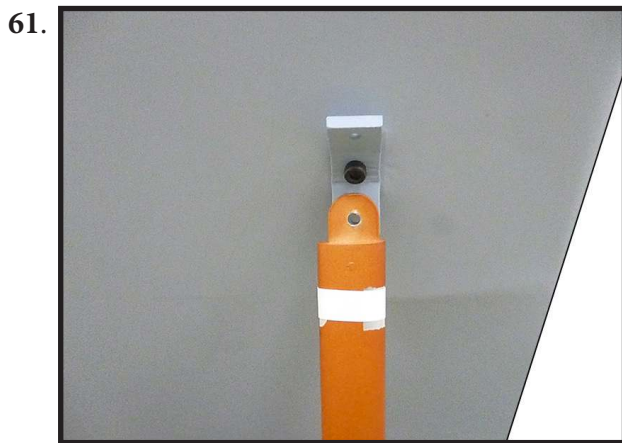
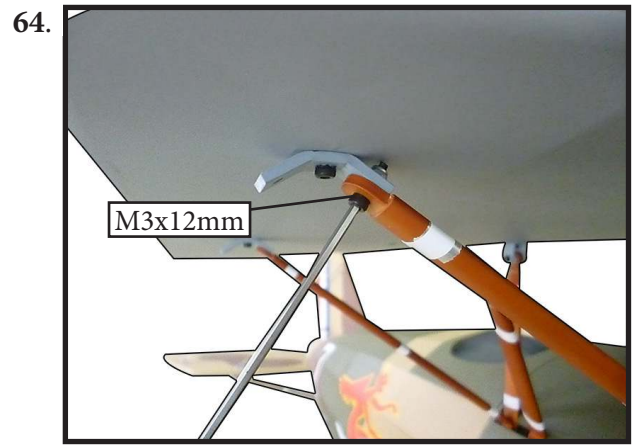
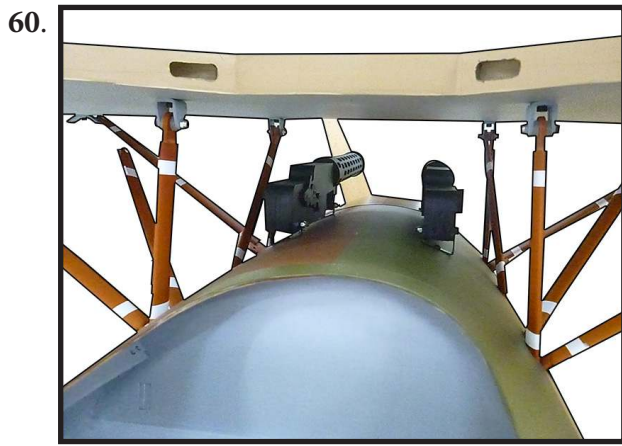

Take the number 6 strut in the middle and attach it to the fuselage. connect from 2 to 5.

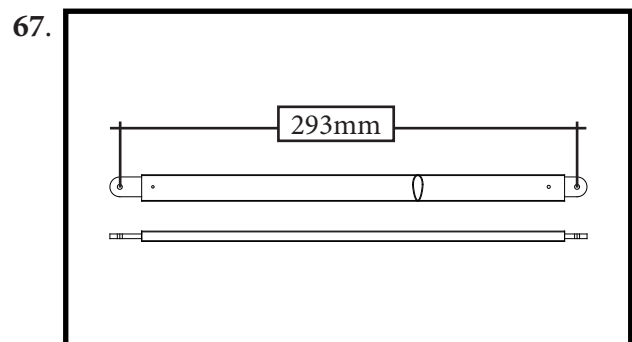
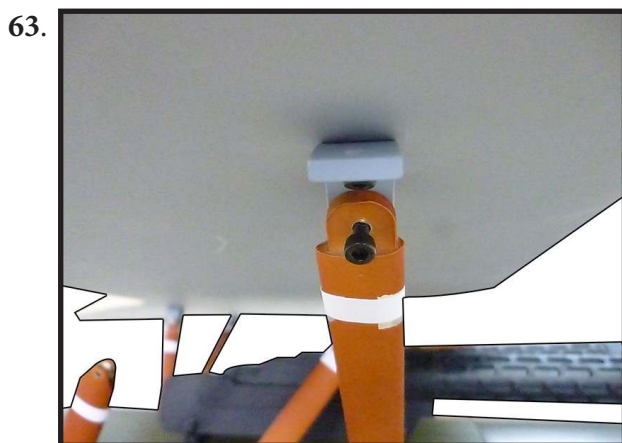
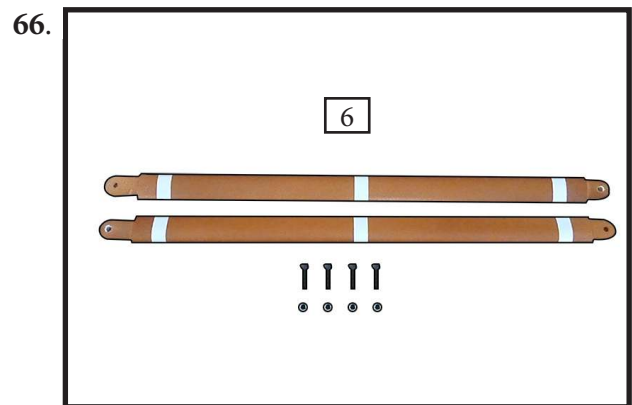

68.

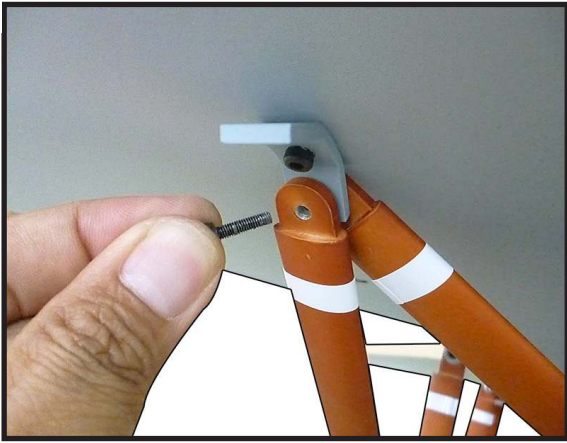

72.

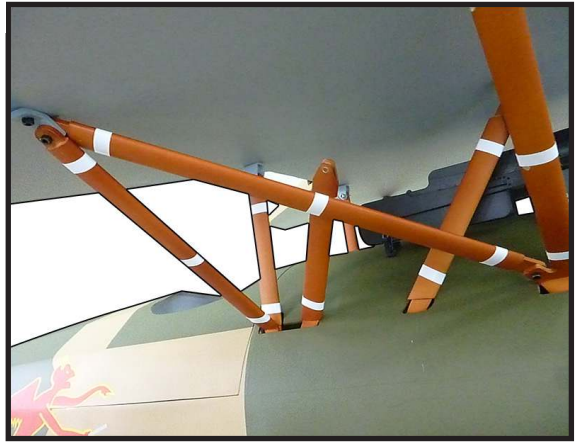

69.

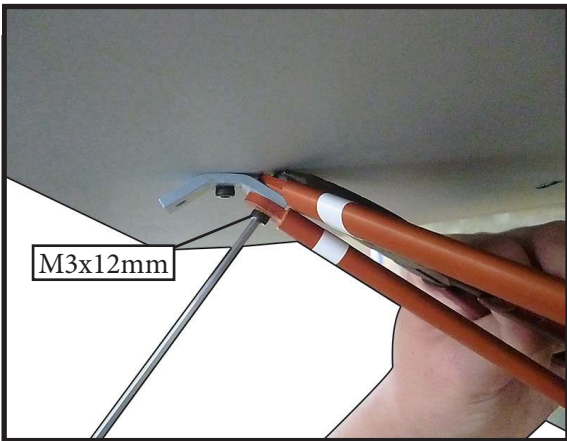

73.

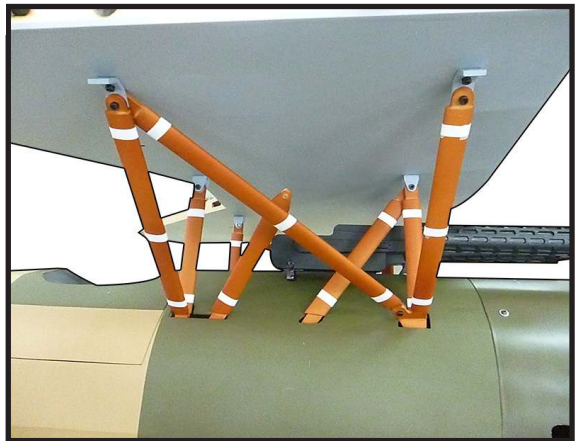

70.

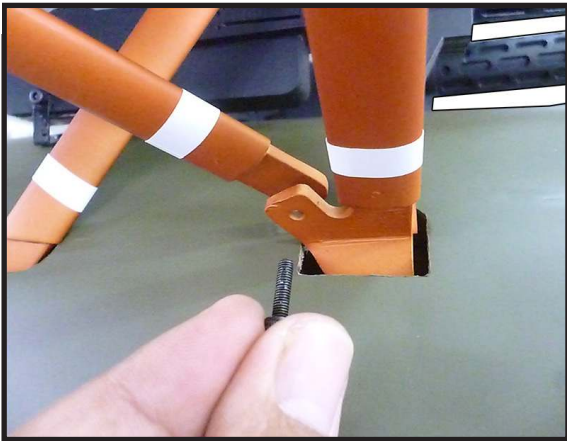

74.

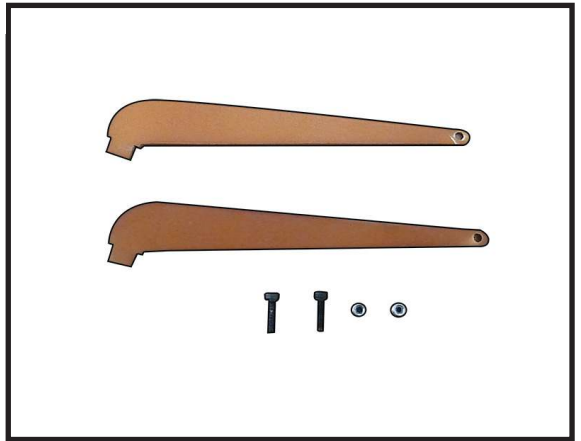

71.



75.

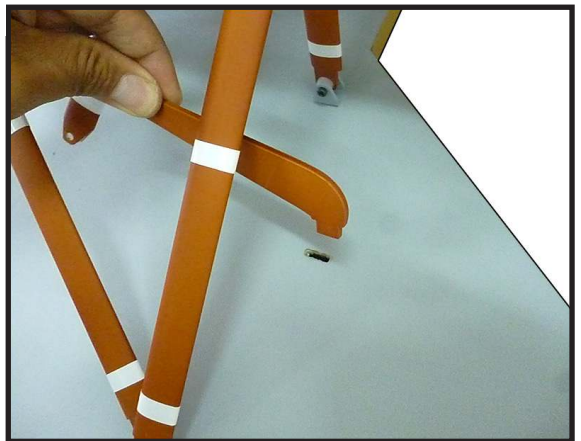

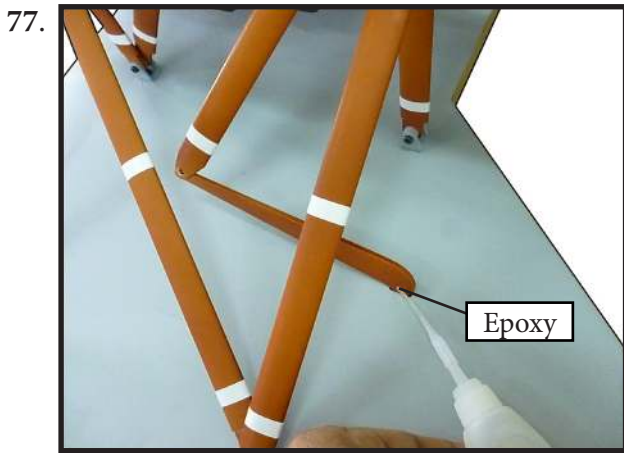
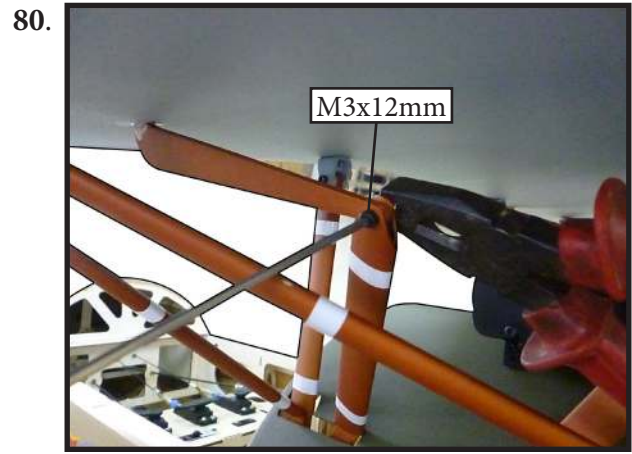

INSTALLATION COCKPIT

Locate items necessary to install.

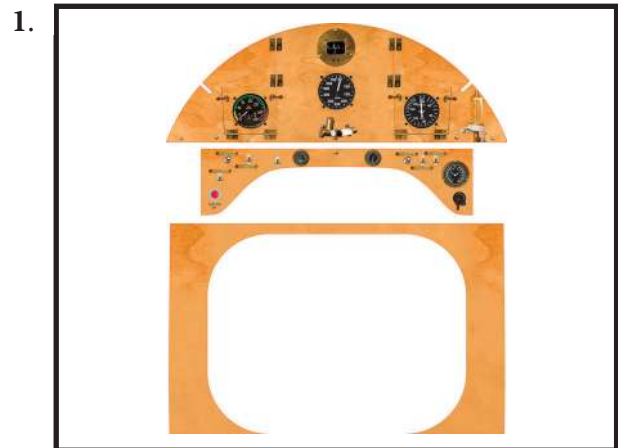

2.

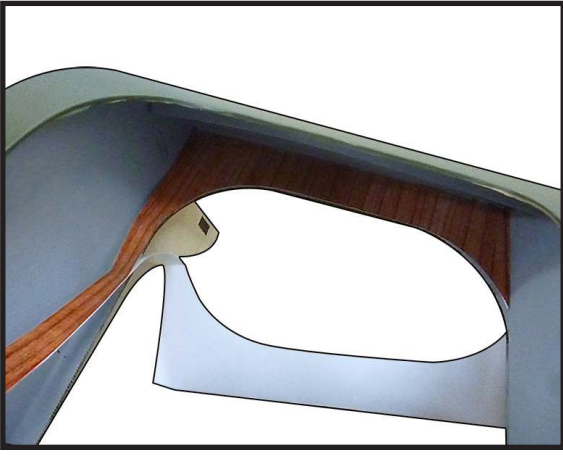

6.



3.

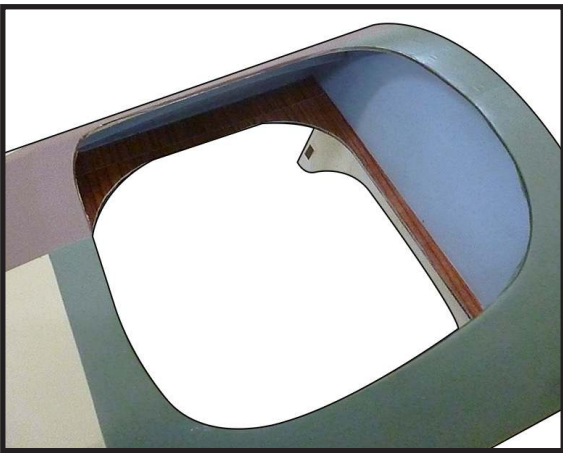

7.



4.

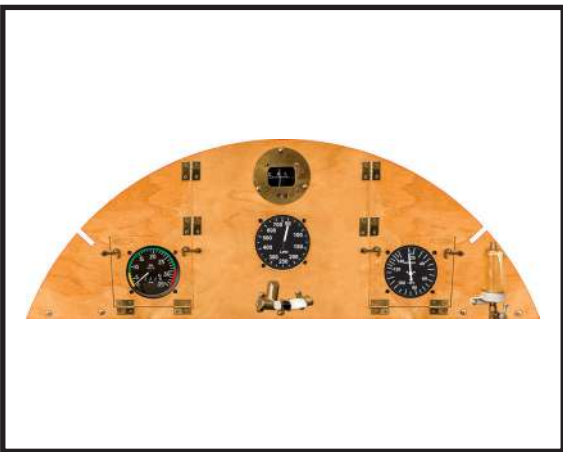

8.



5.



INSTALLATION PILOT AND CANOPY

Locate items necessary to install.



8.



3.

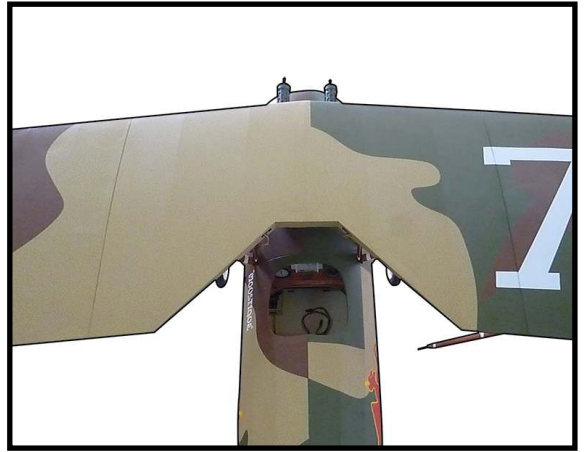

ATTACHMENT WING- FUSELAGE

Attach the aluminium tube into fuselage.

1.

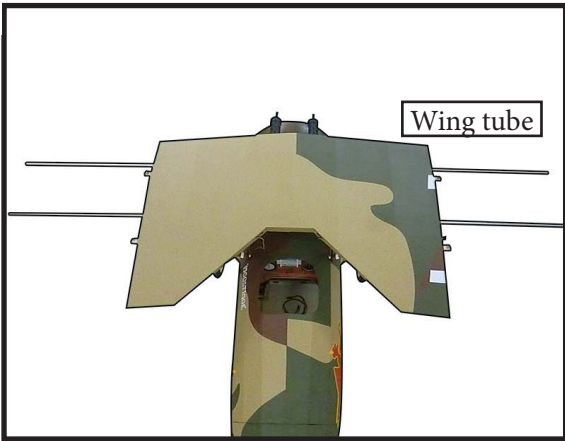

4.

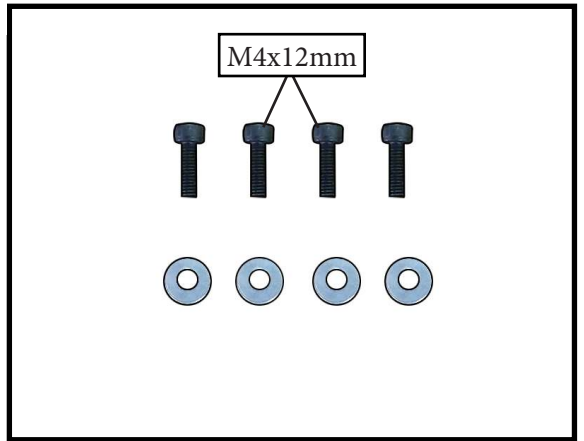

2.

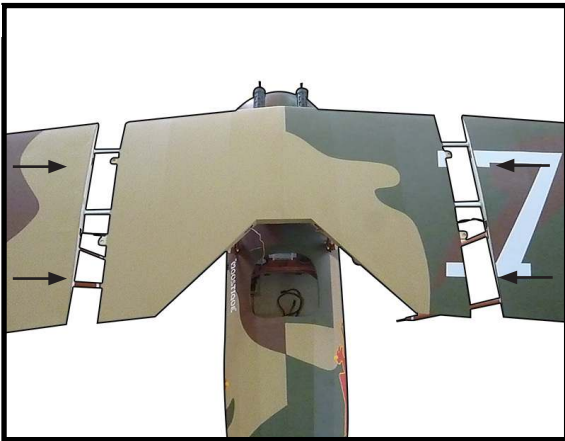

5.

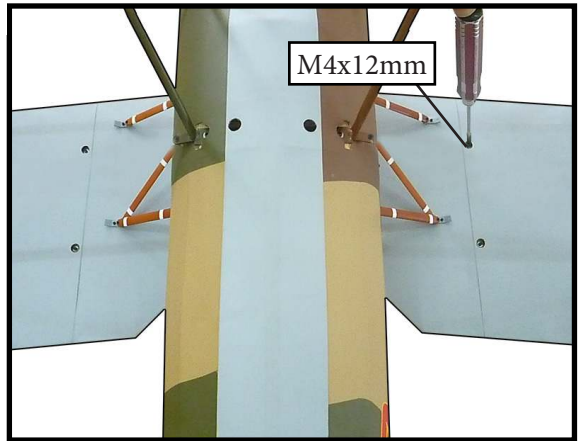

6.

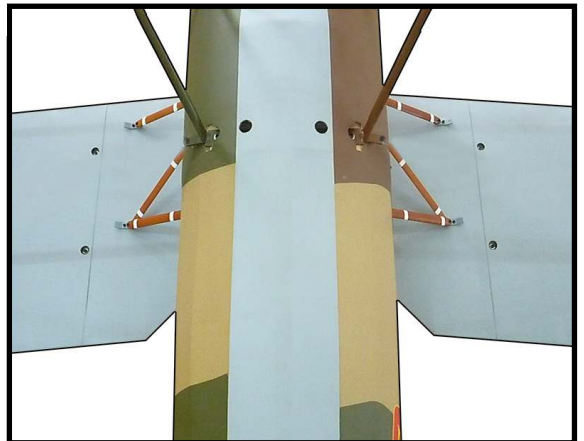

INSTALLATION WING STRUTS

Locate the items for this section of the manual.

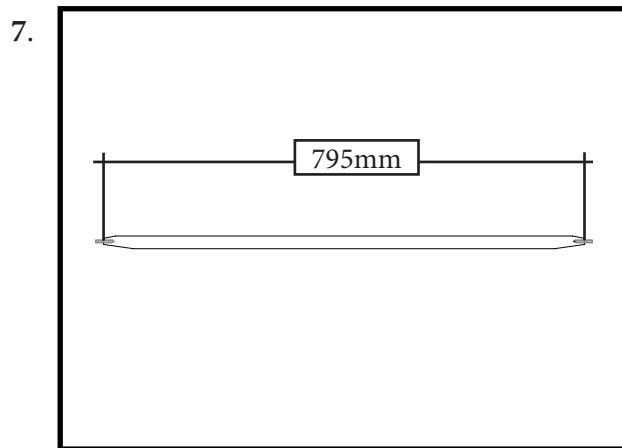
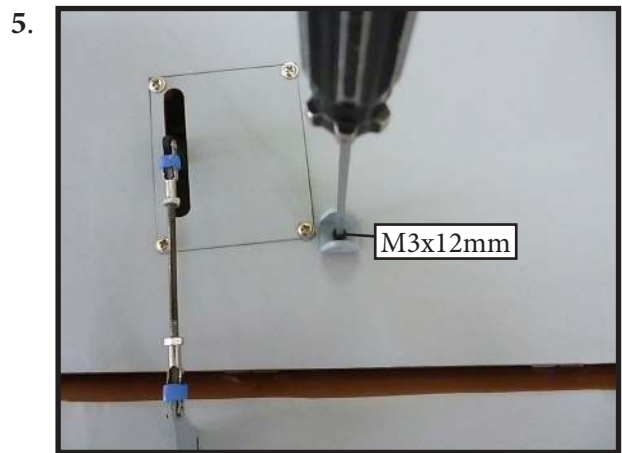
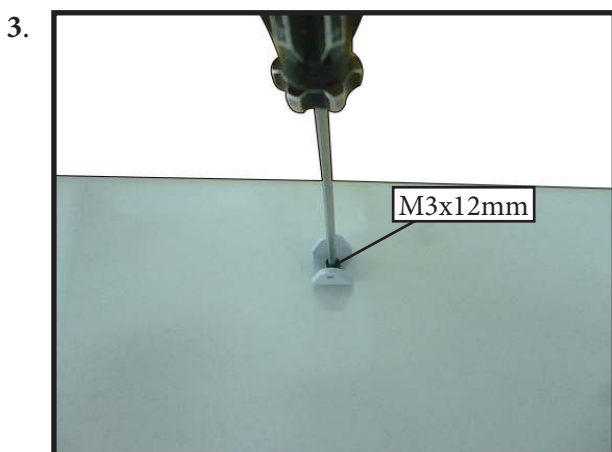
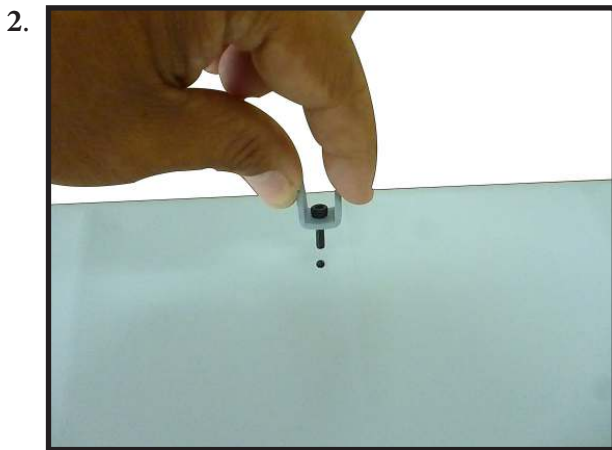
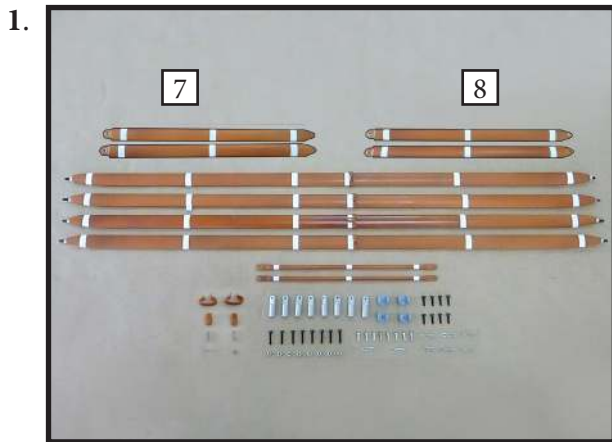

8.

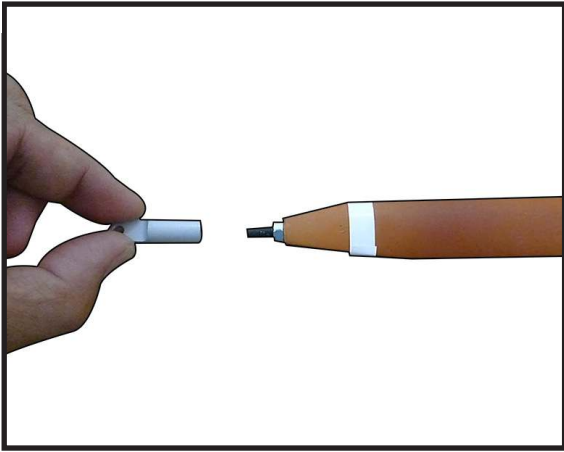

12.

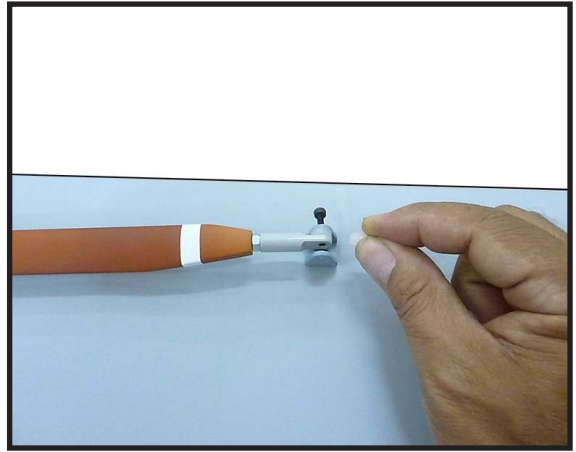

9.

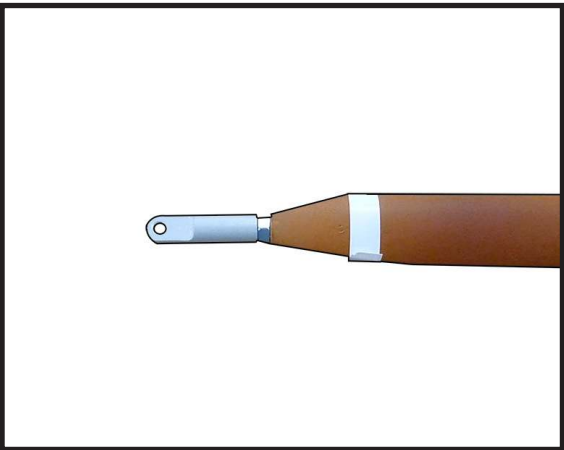

13.

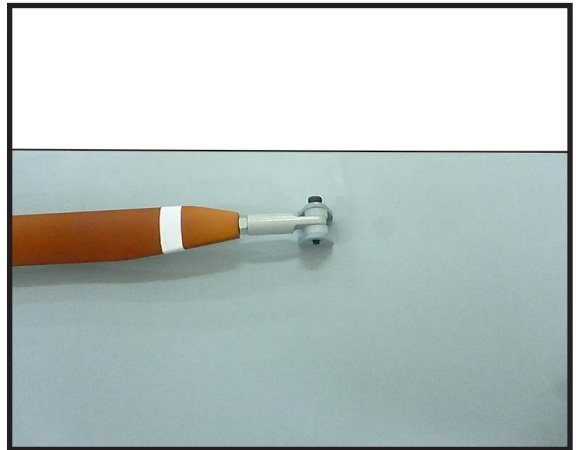

10.

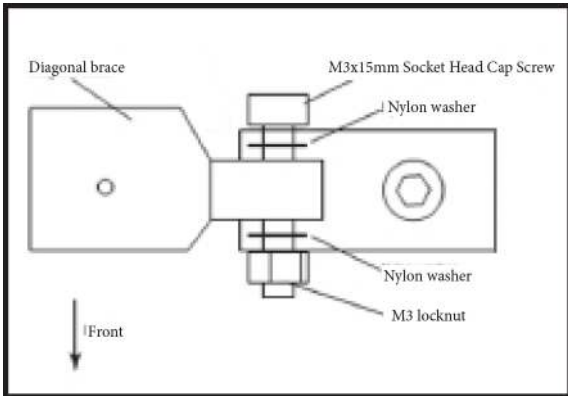

14.

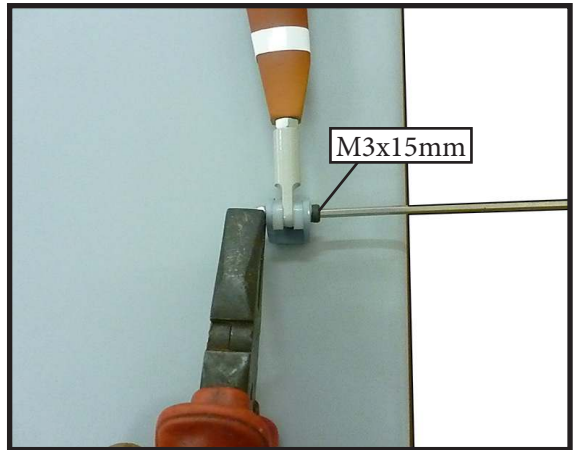

11.

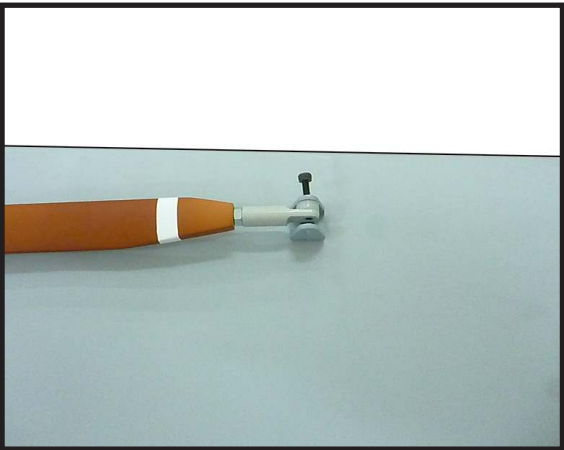

15.

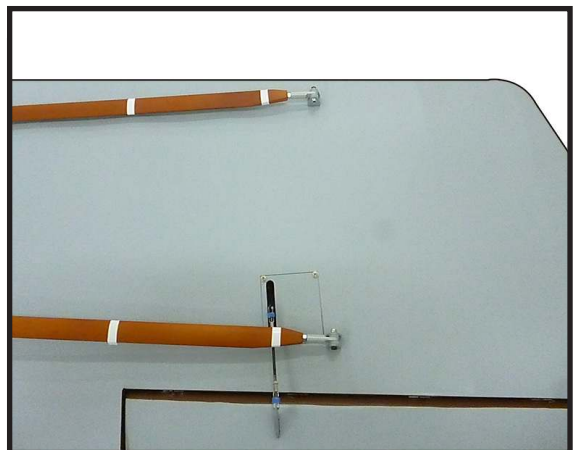

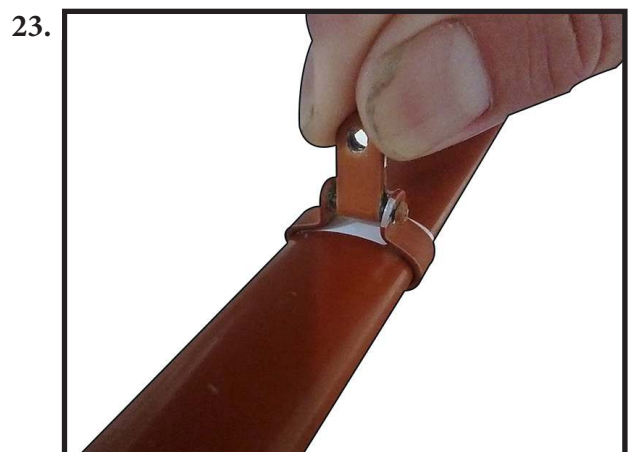
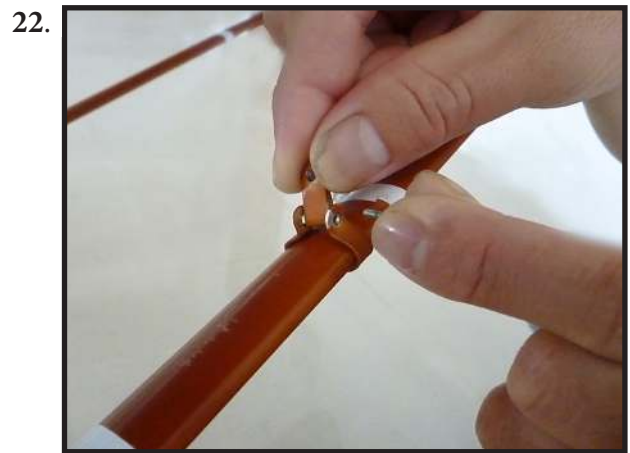
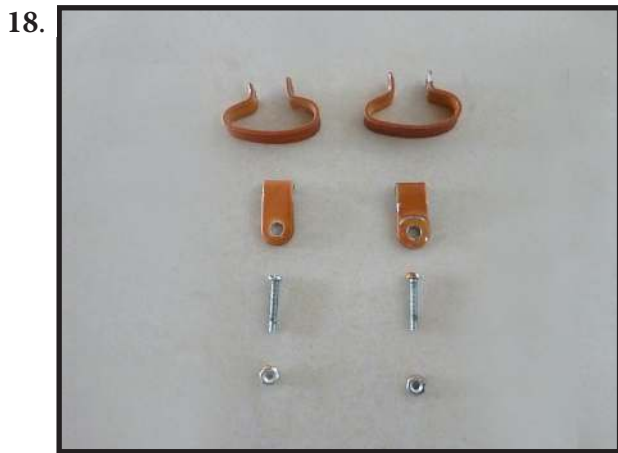
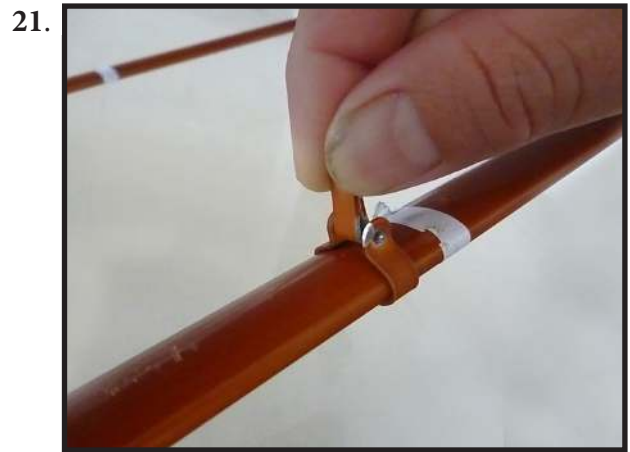
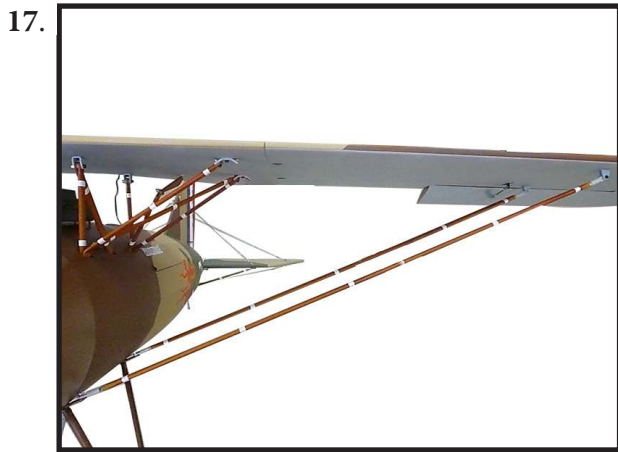
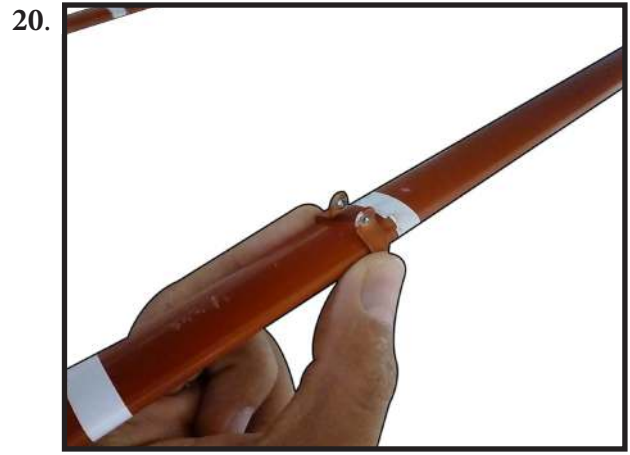
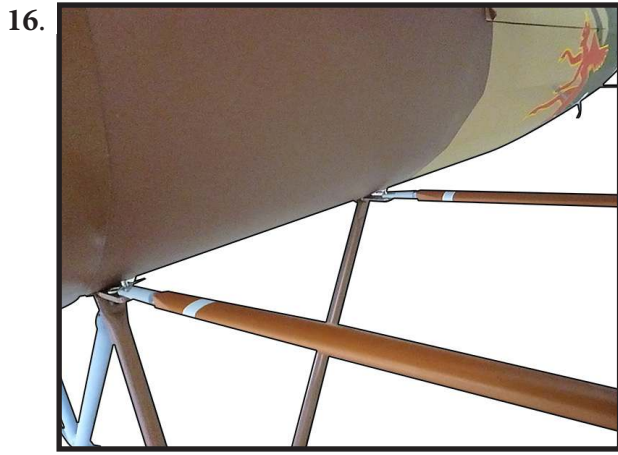

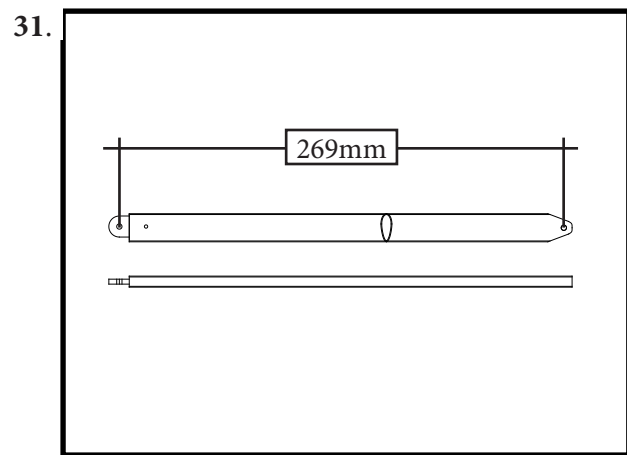
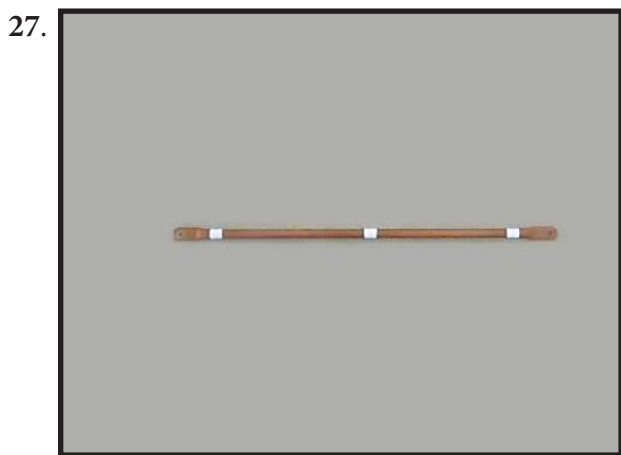
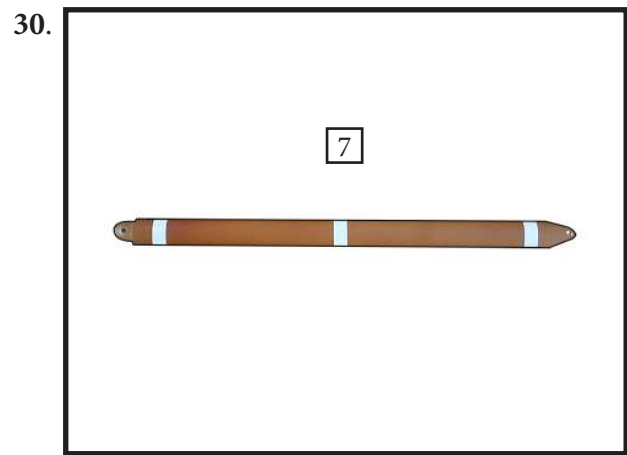
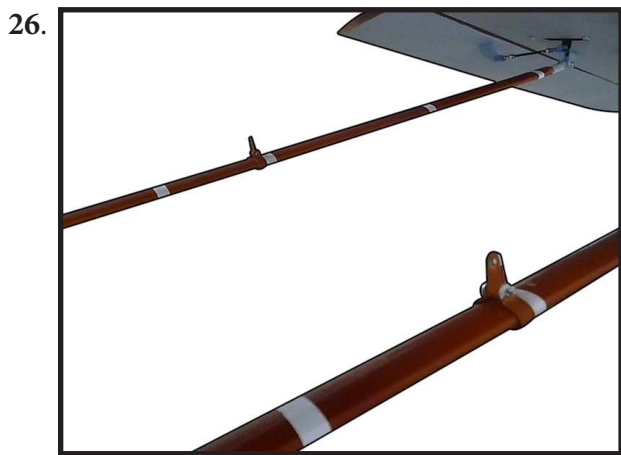
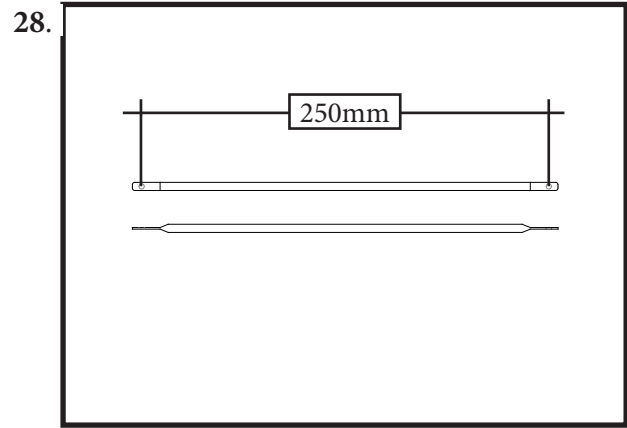

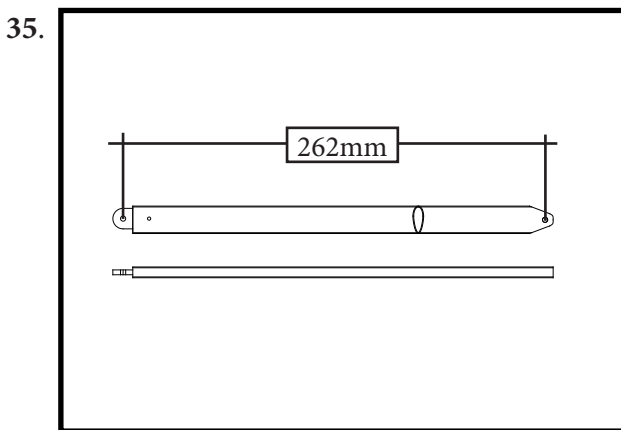
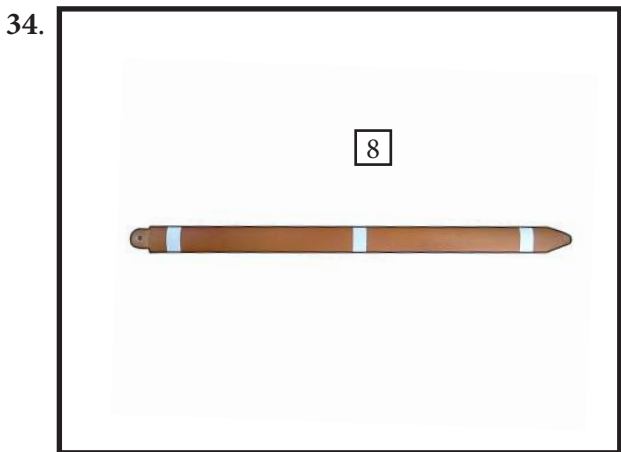
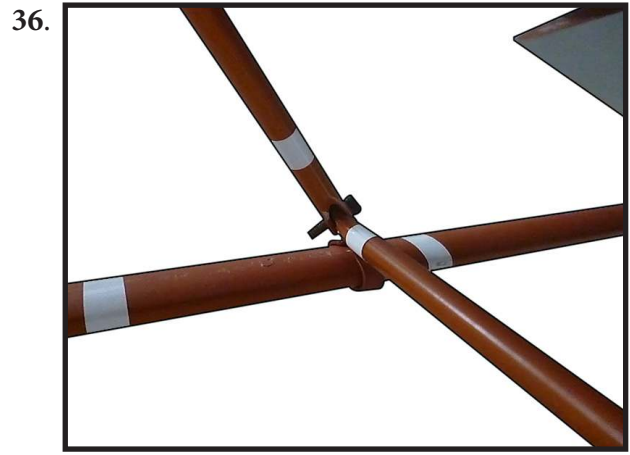

40.

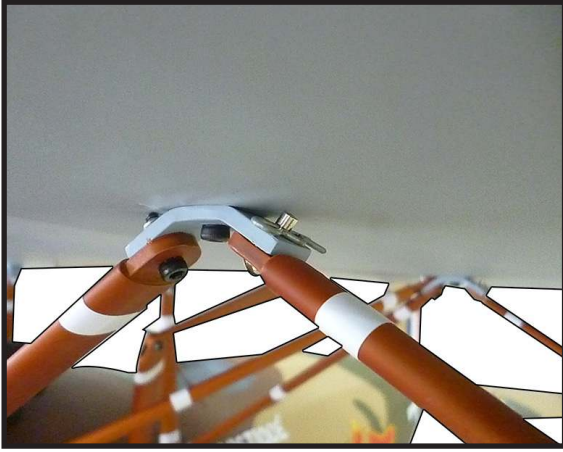

44.

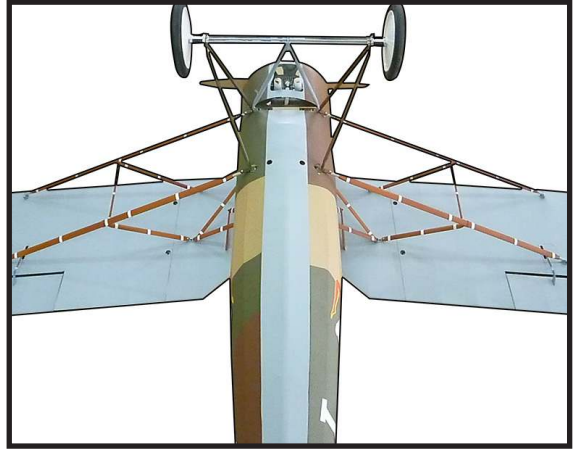

41.

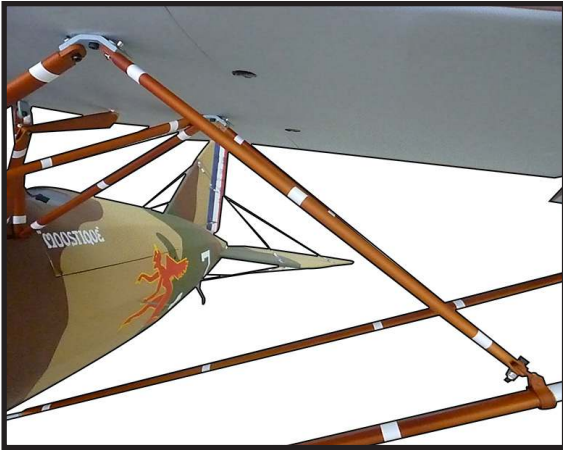

42.

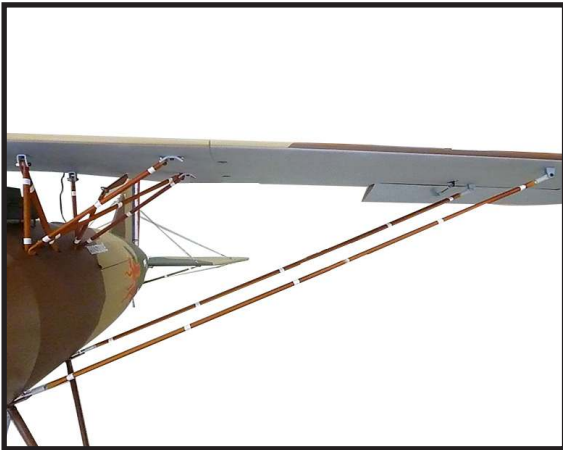

43.

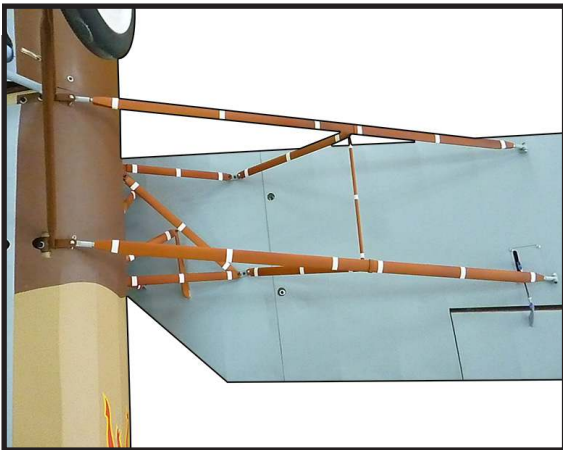

APPLY THE DECALS

1) If all the decals are pre-cut and ready to stick. Please be certain the model is clean and free from oily fingerprints and dust. Position decal on the model where desired, using the photos on the box and aid in their location.

2) If all the decals are not pre-cut, please use scissors or a sharp hobby knife to cut the decals from the sheet. Please be certain the model is clean and free from oily fingerprints and dust. Position decal on the model where desired, using the photos on the box and aid in their location.

BALANCING

An important part of preparing the aircraft for flight is properly balancing the model.

1) Attach the wing panels to the fuselage. Make sure to connect the leads from the aileron to the appropriate leads from the receiver. Make sure the leads are not exposed outside the fuselage before tightening the wing bolts. Your model should be flight-ready before balancing.

2) The recommended Center of Gravity (CG) location for your model is (150-170mm) back from the leading edge at the center of the wing.

3) When balancing your model, make sure it is assembled and ready for flight. Support the plane upright at the marks made on the wing with your fingers or a commercially available balancing stand. This is the correct balance point for your model.

*If possible, first attempt to balance the model by changing the position of the receiver battery and receiver. If you are unable to obtain good balance by doing so, then it will be necessary to add weight to the nose or tail to achieve the proper balance point.

With the wing attached to the fuselage, all parts of the model installed (ready to fly), and empty fuel tanks, hold the model at the marked balance point with the stabilizer level.

Lift the model. If the tail drops when you lift, the model is "tail heavy" and you must add weight* to the nose. If the nose drops, it is "nose heavy" and you must add weight* to the tail to balance.

1.

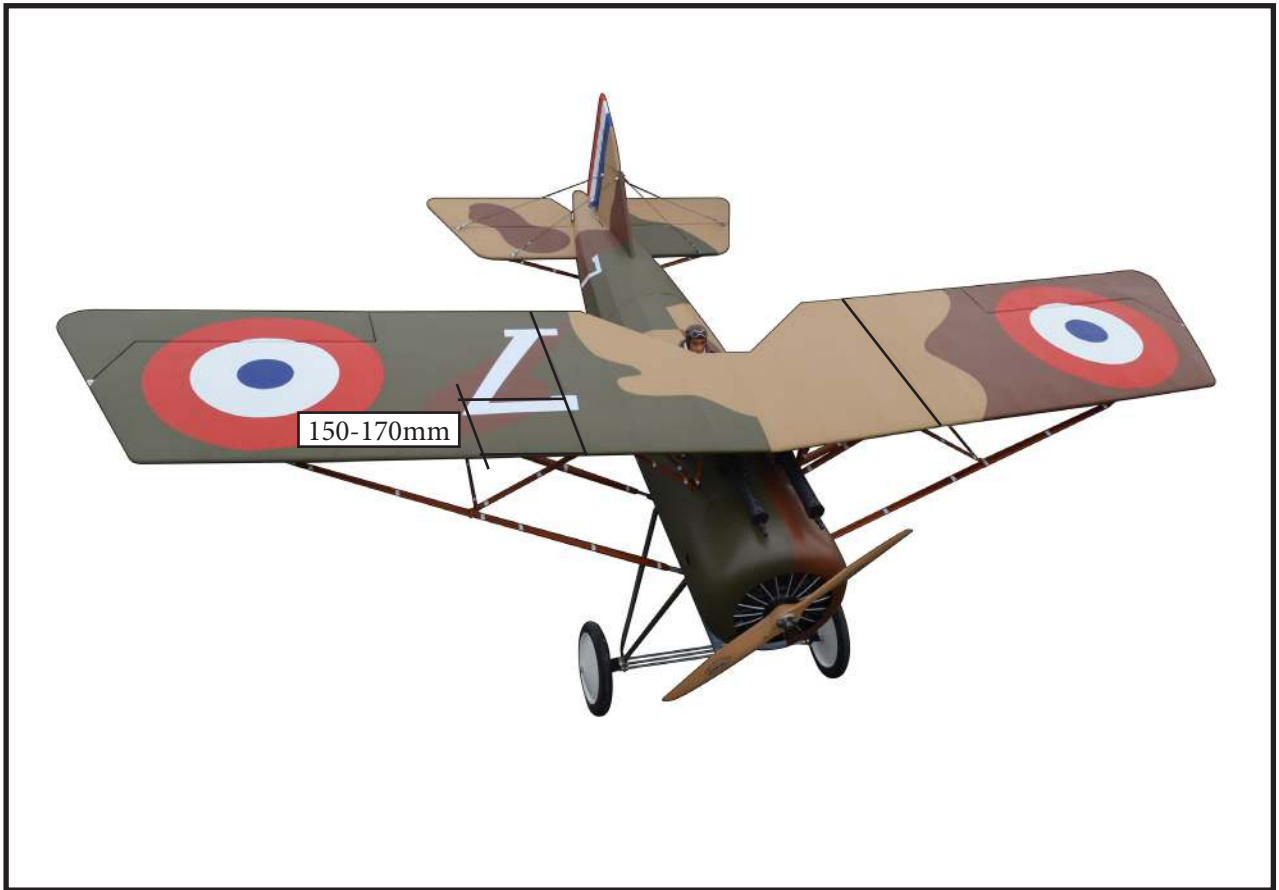

CONTROL THROWS

Ailerons:

High Rate :

Up : 50 mm

Down : 50 mm

Low Rate :

Up : 30 mm

Down : 30 mm

Rudder:

High Rate :

Right : 60 mm

Left : 60 mm

Low Rate :

Right : 40 mm

Left : 40 mm

Elevator:

High Rate :

Up : 50 mm

Down : 50 mm

Low Rate :

Up : 35 mm

Down : 35 mm

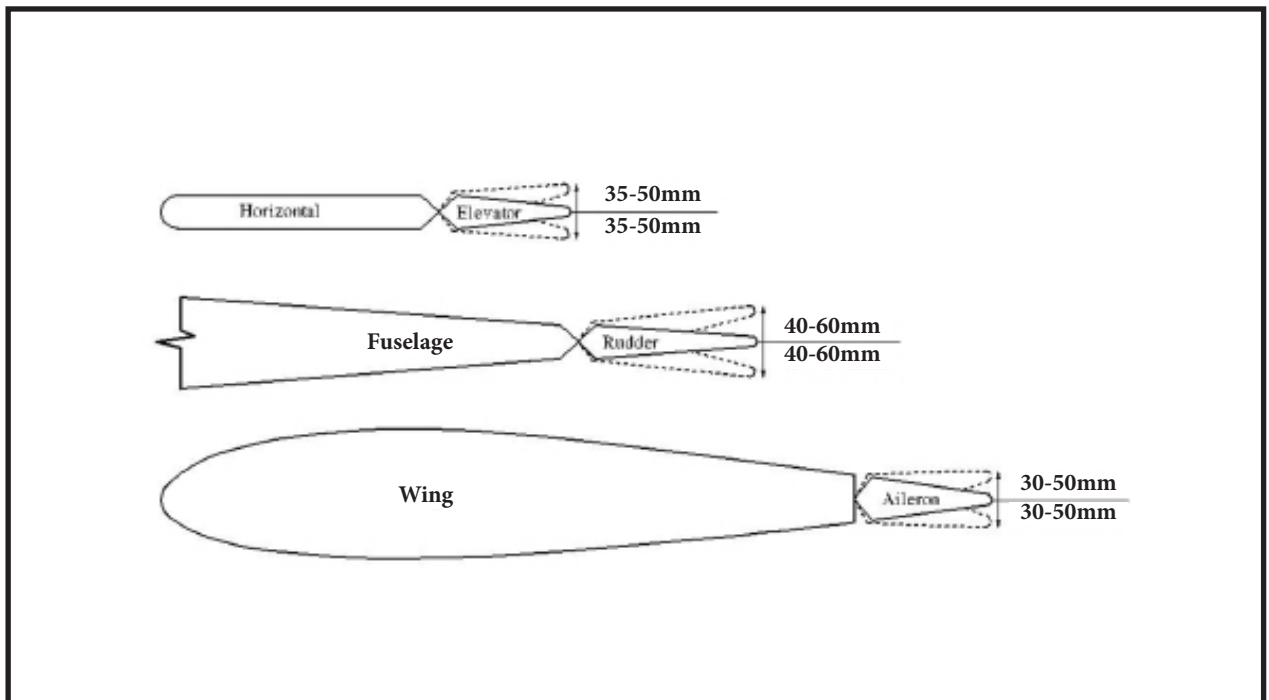

FLIGHT PREPARATION

Check the operation and direction of the elevator, rudder, ailerons and throttle.

□ A) Plug in your radio system per the manufacturer's instructions and turn everything on.

□ B) Check the elevator first. Pull back on the elevator stick. The elevator halves should move up. If they do not, flip the servo reversing switch on your transmitter to change the direction.

□ C) Check the rudder. Looking from behind the airplane, move the rudder stick to the right. The rudder should move to the right. If it does not, flip the servo reversing switch on your transmitter to change the direction.

□ D) Check the throttle. Moving the throttle stick forward should open the carburetor barrel. If it does not, flip the servo reversing switch on your transmitter to change the direction.

□ E) From behind the airplane, look at the aileron on the right wing half. Move the aileron stick to the right. The right aileron should move up and the other aileron should move down. If it does not, flip the servo reversing switch on your transmitter to change the direction.

PREFLIGHT CHECK

□ 1) Completely charge your transmitter and receiver batteries before your first day of flying.

□ 2) Check every bolt and every glue joint in the **1/3 Scale Morane Saulnier AI** to ensure that everything is tight and well bonded.

□ 3) Double check the balance of the airplane. Do this with the fuel tank empty.

□ 4) Check the control surfaces. All should move in the correct direction and not bind in any way.

□ 5) If your radio transmitter is equipped with dual rate switches double check that they are on the low rate setting for your first few flights.

□ 6) Check to ensure the control surfaces are moving the proper amount for both low and high rate settings.

□ 7) Check the receiver antenna. It should be fully extended and not coiled up inside the fuselage.

□ 8) Properly balance the propeller. An out of balance propeller will cause excessive vibration which could lead to engine and/or airframe failure.

*We wish you many safe and enjoyable flights
with your 1/3 Scale Morane Saulnier AI.*

*If you have any queries, or are interested in our products,
please feel free to contact us*

Factory : 12/101A - Hamlet 4 - Le Van Khuong Street - Dong Thanh Ward -
Hoc Mon District - Ho Chi Minh City - Viet Nam.

Office : 62/8 Ngo Tat To Street - Ward 19 - Binh Thanh District - Ho Chi Minh
City - Viet Nam

Phone : 848 - 86622289 or 848- 36018777

Website : www.SeagullModels.com

Email : Sales@seagullmodels.com

Facebook : www.facebook.com/SeaGullModels.